

EXCELSYS FC2500 SERIES

FC25M MEDICAL CAPACITOR CHARGING
AND AC-DC POWER SUPPLY



FLEXICHARGE
by Advanced Energy

Advanced Energy's FC25M medical capacitor charging power supply, with a built in configurable AC-DC power supply is designed to provide the system power needs for medical laser applications. The FC25M can be used as a standalone capacitor charger, and if needed, various low voltage modules can be added to the unit to provide further system power. This functionality provides extra flexibility to power other systems and applications. The supply can support analog and digital control using our PMBus interface.

PRODUCT HIGHLIGHTS

Capacitor Charger

- Up to 2500 Watts
- 0 to 1000 VDC
- Excellent pulse to pulse stability
- User power limit control
- Internal fan cooled

AC-DC Power Supply

- Up to 800 Watts
- Up to 10 isolated outputs
- Series and parallel outputs — higher voltages/currents

Reliability

- MTBF > 900,000 hours
- Level 4 input surge protection
- 3 W, 5 V auxiliary power on system signal connector J8
- 3 W, 15 V auxiliary power on capacitor charger D-SUB connector
- Safety approved to 3000 m altitude
- 85% Efficiency

Flexibility

Analog and digital management —
PMBus™ monitoring and control capability

TYPICAL APPLICATIONS

Capacitor Charger

Medical laser application examples:
Surgical lasers, laser treatment, laser
aesthetic treatments

AC-DC Power Supply

- Low voltage system power
- Power for onboard computers and displays
- Pump power
- Power for cooling and heating
- Power for other treatments

AT A GLANCE

	Charger	AC-DC
Power	2500 W	800 W
Slots	NA	5

Cooling

Internal fan cooled

Parameters

348 mm x 145 mm x 106 mm

Certification and Compliance

Medical

- IEC60601-1 3rd edition,
IEC60601-1-2 4th edition (EMC)

FC2500 SERIES

CAPACITOR CHARGER UNIT

Capacitor Charger					
Parameter	Conditions/Description	Min	Nom	Max	Units
Output Voltage	The output voltage is adjustable (analog or digital)	0	—	1000	VDC
Output Power		0	—	2500	W
Output Current	The power limits the maximum output current to < 6 A for V_{OHV} , ie, $I_{OHV_Max} = P_{OHV_Max}/V_{OHV}$ for $V_{OHV} > 275$ V	0	—	10	A
Capacitive Loading		50	—	—	μ F
Pulse-to-Pulse Repeatability		-2	—	2	VDC
Output Voltage Adjustment Accuracy	For $V_{OHV} > 80$ V	—	—	1	%
Output Voltage Drift with Temperature		—	—	0.02	%/ $^{\circ}$ C
Output Power Limit Adjustment	Adjustable using 'PLim_User' according to: $P_{OHV_Max} = 800 + 'PLim_User' \times 85$ [W]	800	—	2750	W
Output Power Limit Adjustment Accuracy		—	—	3	%
Turn-On Delay	Time from application of input AC to output current regulation	—	—	2,000	mS
Enable Delay	Time from 'Inhibit' > 2 V to output current regulation	—	—	2	mS
Disable Delay	Time from 'Inhibit' < 1 V to output current turned off	—	—	1	mS

MODULES

CoolX CoolMods				
Single Output Modules (1 Slot)	Vnom (V)	Set Point Adjust Range (V)	I _{max} (A)	Power (W)
CmA	5	2.5-6.0	21.0	105
CmB ¹	12	6.0-15.0	15.0	180
CmC	24	15.0-28.0	8.3	200
CmD	48	28.0-58.0	4.16	200
Dual Output Modules (1 Slot)				
CmG ² V1	24	3.0-30.0	3.0	90
V2	24	3.0-30.0	3.0	90
CmH ³ V1	5	3.0-6.0	6.0	36
V2	24	3.0-30.0	3.0	90
Wide Trim Modules (1 Slot)				
CmA-W01	5	1.0-6.0	21.0	105
CmB-W01	12	1.0-15.0 ²	15.0	180
CmC-W01	24	2.0-28.0	8.3	200
CmD-W01	48	3.0-58.0 ³	4.16	200
High Voltage Modules (1 Slot)				
CmK	200	175-205	0.66	132

* SEMI F47 compliant at input voltages > 180 VAC. Consult Advanced Energy for details.

¹ Full dynamic specifications may not be met at full load when output voltage is trimmed by above 13 V.

² For the CmG module, the max combined power of both outputs is 120 W.

³ For the CmH module, the max combined power of both outputs is 100 W.

FC2500 SERIES

ELECTRICAL SPECIFICATIONS

Input					
Parameter	Conditions/Description	Min	Nom	Max	Units
Nominal Input Voltage Range	Universal Input 47 to 63 Hz	200	—	240	VAC
AC Operating Input Range		120	—	264	VAC
Input Current		—	—	23.2	A
Inrush Current	230 VAC	—	—	50	A
Power Factor	230 VAC @ full power	0.95	—	—	—
Input Fuses Rating	Dual Fused (Line and Neutral) 500 VAC	—	20	—	A
Efficiency		85	—	—	%

CoolMod Output					
Parameter	Conditions/Description	Min	Nom	Max	Units
Single Output Modules (1 Slot)					
Line Regulation	From minimum to maximum rated voltage	—	—	±0.2	%
Load Regulation	For 0 to 100% load change	—	—	±0.4	%
Transient Response	For 25% to 75% load change, 0.5 A/μs: voltage deviation	—	—	±6	%
	For 25% to 75% load change, 0.5 A/μs: settling time	—	—	500	μs
Ripple and Noise	Peak-Peak, 20 MHz BW, 100 mV or % of nominal	—	—	1.25	%
Overvoltage Protection	Tracking OVP (autorecovery, % of setpoint)	103	—	125	%
	Hiccup OVP (% of maximum voltage)	107	—	160	%
Remote Sense	Maximum cable drop compensation	—	—	0.5	VDC
Rise Time	Monotonic	—	—	5	ms
Turn-On Delay	From AC Input	—	—	2000	ms
	From Global Enable	—	—	12	ms
	From CoolMod Enable	—	—	12	ms
Hold-Up Time	For nominal output voltage at full load	16	—	—	ms
Overcurrent Protection	Straight line current limit with hiccup protection at 35% Vo nom	105	—	130	%
Short Circuit Protection	Hiccup, Autorecovery	—	—	—	—
Overtemperature Protection	Autorecovery	—	—	—	—
Capacitive Load		—	—	10	mF
Dual Output Modules (1 Slot)					
Line Regulation	From minimum to maximum rated voltage	—	—	±0.5	%
Load Regulation	For 0 to 100% load change	—	—	±2	%
Transient Response	For 25% to 75% load change, 0.5 A/μs: voltage deviation	—	—	±10	%
	For 25% to 75% load change, 0.5 A/μs: settling time	—	—	1000	μs
Ripple and Noise	Peak-Peak, 20 MHz BW, 100 mV or % of nominal	—	—	2	%
Overvoltage Protection	Hiccup OVP (% of maximum voltage)	110	—	130	%
Rise Time	Monotonic	—	—	20	ms
Turn-On Delay	From AC Input	—	—	2000	ms
	From Global Enable	—	—	100	ms
	From CoolMod Enable	—	—	100	ms

ELECTRICAL SPECIFICATIONS (CONTINUED)

Hold-Up Time	For nominal output voltage at full load	10	16	—	ms
Overcurrent Protection	Hiccup, Autorecovery	165	—	335	%
Short Circuit Protection	Hiccup, Autorecovery	—	—	—	—
Overtemperature Protection	Hiccup, Autorecovery	—	—	—	—
Capacitive Load		—	—	270	μF
Wide Trim Power Modules (1 Slot)					
Line Regulation	From minimum to maximum rated voltage	—	—	±0.25	%
Load Regulation	For 0 to 100% load change	—	—	±0.4	%
Transient Response	For 25% to 75% load change, 0.5 A/μs: voltage deviation	—	—	±6	%
	For 25% to 75% load change, 0.5 A/μs: settling time	—	—	500	μs
Ripple and Noise	Peak-Peak, 20 MHz BW, 100 mV or % of nominal	—	—	1.25	%
Overvoltage Protection	Tracking OVP (autorecovery, % of setpoint)	103	—	125	%
	Hiccup OVP (% of maximum voltage)	107	—	160	%
Remote Sense	Maximum cable drop compensation	—	—	0.5	VDC
Rise Time	Monotonic	—	—	5	ms
Turn-On Delay	From AC Input	—	—	2000	ms
	From Global Enable	—	—	12	ms
	From CoolMod Enable	—	—	12	ms
Hold-Up Time	For nominal output voltage at full load	16	—	—	ms
Overcurrent Protection	Straight line current limit with hiccup protection at 35% Vo nom	105	—	130	%
Short Circuit Protection	Hiccup, Autorecovery	—	—	—	—
Overtemperature Protection	Autorecovery	—	—	—	—
Capacitive Load		—	—	10	mF
High Voltage Modules (1 Slot)					
Line Regulation	From minimum to maximum rated voltage	—	—	±0.5	%
Load Regulation	For 0 to 100% load change	—	—	±1.0	%
Transient Response	For 25% to 75% load change, 0.5 A/μs: voltage deviation	—	—	±3.75	%
	For 25% to 75% load change, 0.5 A/μs: settling time	—	—	500	μs
Ripple and Noise	Peak-Peak, 20 MHz BW, 100 mV or % of nominal	—	—	1.0	%
Overvoltage Protection	Tracking OVP (autorecovery, % of setpoint)	103	—	125	%
	Hiccup OVP (% of maximum voltage)	112	—	122	%
Rise Time	Monotonic	—	—	20	ms
Turn-On Delay	From AC Input	—	—	2000	ms
	From Global Enable	—	—	30	ms
	From CoolMod Enable	—	—	30	ms
Hold-Up Time	For nominal output voltage at full load	16	—	—	ms
Overcurrent Protection	Straight line current limit with hiccup protection at 35% Vo nom	105	—	130	%
Short Circuit Protection	Hiccup, Autorecovery	—	—	—	—
Overtemperature Protection	Autorecovery	—	—	—	—
Capacitive Load		—	—	10	μF

Auxiliary Output

Parameter	Conditions/Description	Min	Nom	Max	Units
Auxiliary Output Voltage	Aux Voltage A	14.7	15	15.3	V
	Aux Voltage B	4.8	5	5.2	V

FC2500 SERIES

ELECTRICAL SPECIFICATIONS (CONTINUED)

Load Regulation	Aux Voltage A		—	—	±2	%
	Aux Voltage B		—	—	±2	%
Line Regulation	Aux Voltage A	For ±10% change from nominal line	—	—	±0.5	%
	Aux Voltage B		—	—	±0.5	%
Ripple and Noise	Aux Voltage A	Peak-Peak, 20 MHz BW, % of nominal	—	—	1	%
	Aux Voltage B		—	—	4	%
Maximum Output Current	Aux Voltage A		—	—	0.2	A
	Aux Voltage B		—	—	0.6	A
Maximum Output Capacitive Load	Aux Voltage A	Assuming resistive load	—	—	100	μF
	Aux Voltage B		—	—	1000	μF
Output Overcurrent Protection	Aux Voltage A	Yes, hiccup with autorecovery	105	—	130	%
	Aux Voltage B		105	—	140	%
Short Circuit Protection	Aux Voltage A	Yes, hiccup with autorecovery	—	—	—	
	Aux Voltage B		—	—	—	

Galvanic Isolation

Parameter	Conditions/Description	Min	Nom	Max	Units
Input to Output	Reinforced (2 x MOPP); contact Advanced Energy for Hi-Pot instructions	4000	—	—	VAC
Input to Case	Basic (1 x MOPP)	1850	—	—	VAC
Output to Case	Basic (1 x MOPP)	1850	—	—	VAC
Output to Output	Basic (1 x MOPP)	1850	—	—	VAC
Output to Output (Dual)	CmG, CmH V1-V2	500	—	—	VDC

Reliability

Parameter	Conditions/Description	Min	Nom	Max	Units	
MTBF	Telecordia SR-332, Issue 4	CoolPac	—	1.11	—	Fpmh
		CoolMod	—	0.11	—	Fpmh
MTBF	Telecordia SR-332, Issue 4	CoolPac	—	900,000	—	Hours
		CoolMod	—	—	—	Hours

ELECTRICAL SPECIFICATIONS (CONTINUED)

Environmental					
Parameter	Conditions/Description	Min	Nom	Max	Units
Operating Temperature		0	—	40	°C
Storage Temperature		-40	—	85	°C
Derating	See derating curves included in the Designers Manual	—	—	—	—
Relative Humidity	Non-condensing	5	—	90	%RH
Shock and Vibration	MIL-STD-810G Method 514.6	—	—	—	—
Altitude		—	—	3000	m

EMC		
Parameter	Conditions/Description	Criteria
Radiated Emissions ¹	EN 55011, EN 55022 and FCC, Class A	Compliant
Conducted Emissions	EN 55011, EN 55022 and FCC, Class A	Compliant
Power Line Harmonics	EN 61000-3-2, Class A	Compliant
Voltage Flicker	EN 61000-3-3	Compliant
ESD	EN 61000-4-2, level 4, 8 kV contact, 15 kV air	A
Radiated Immunity	EN 61000-4-3, level 3, 10V/m 80-2700 MHz	A
Electrical Fast Transient	EN 61000-4-4, level 4, ±4 kV	A
Surge Immunity	EN 61000-4-5, level 4, 2 kV DM, 4 kV CM	A
Conducted RF Immunity	EN 61000-4-6, level 3, 10 Vemf 150 KHz-80 MHz	A
Power Frequency Magnetic Field	EN 61000-4-8, level 4, 30 A/m	A
Voltage Dips & Interruptions	EN 61000-4-11	A & B Compliant

¹ Consult AE applications for system level compliance

Standards & Directives	
Standard	Conditions/Description
Safety Agency Approvals	EN60601-1
IEC/EN 60601-1, 2005, AMD1:2012	3,000 m (9,800 ft) altitude, 100 to 240 VAC ± 10%
IEC 60601-1-2 Edition 4	IEC 60601-1-2 (2014)
Protection class	Class I
WEEE	Waste Electrical and Electronic Equipment Directive (WEEE) 2002/96/EC
ROHS	EU DIRECTIVE 2011/65/EC RoHS compliancy
REACH	Compliant

FC2500 SERIES

MECHANICAL SPECIFICATIONS

Mechanical Data		
Parameter	Description	
Dimensions (L x W x H)	L x W x H	348 mm x 145 mm x 106 mm
Weight	Nominal Weight: Flexicharge + 5 x Mods	3.75 Kg
Connectors	Description	Mating Connectors (if applicable)
AC/DC Input Terminal Block	DINKLE 0168-1502	—
Main DC Output Terminal Block (CmA-CmD)	M4 Screws	—
Main DC Output Terminal Block (CmG, CmH)	Camden - CTB9350/4A	—
Output Signal Connector (CmG, CmH)	Molex - 87833-0831	—
System Signal Connector J8	Molex 87833-1031 10-way	Locking Molex 51110-1060; Non Locking Molex 51110-1050; Crimp Terminal: Molex p/n 50394 or Molex 51110-1056 which includes locking tab and polarization keying
Output Signal Connectors J1001-J1005	Molex 87833-0631 6-way	Locking Molex 51110-0660; Non Locking Molex 51110-0650; Crimp Terminal: Molex p/n 50394 or Molex 51110-0656 which includes locking tab and polarization keying
Output Sense Connectors J3	JST-S2BPH-K(LF)(SN)	JST PHR2. Crimp Terminal JST BPH-002TP0.5S or SPH-002T-P05S

FC25M Mechanical Drawings

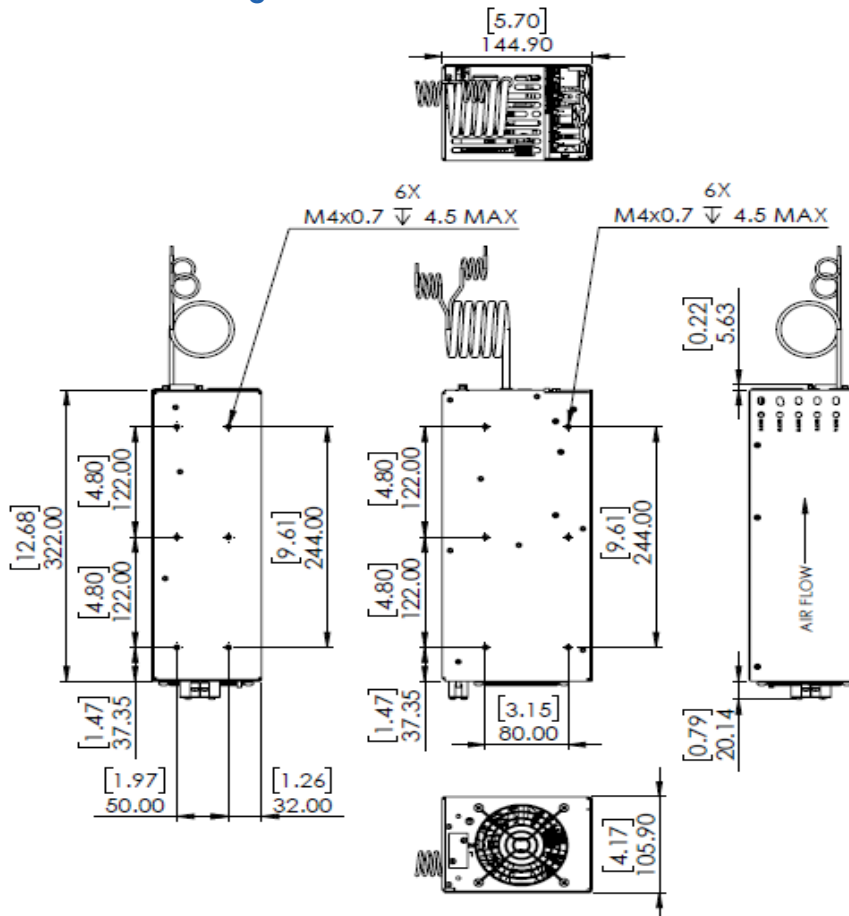

*Maximum screw penetration from base does not exceed 4.5 mm.

FC25 can be mounted on its base, vertically or on its side. FC25 can also be mounted on the DIN Rail accessory (Z744).

INTERFACE

Input Connectors

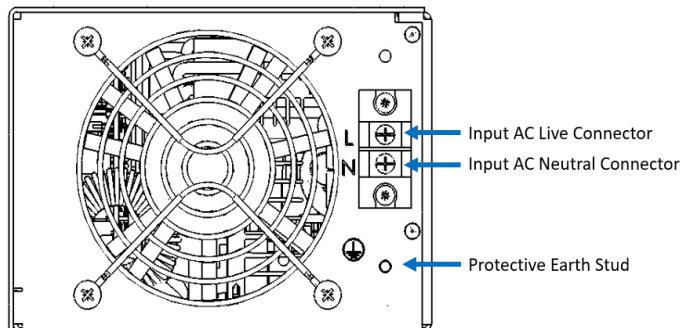

FLEXICHARGE™ Connectors

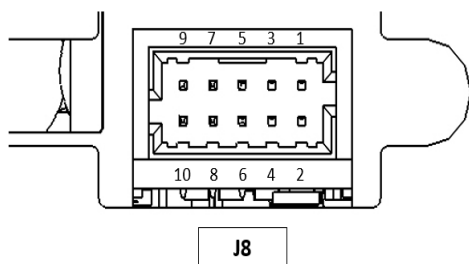
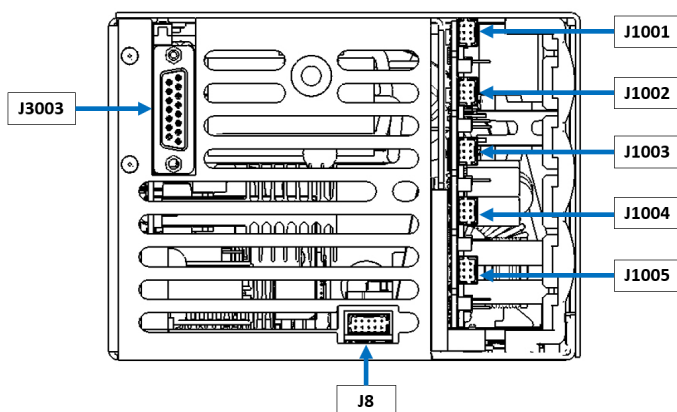

J8 Connector		
Pin	Name	Function
1	Common	Common ground
2	SCL	Communications port
3	LV Global EN	External global enable and disable of modules
4	SDA	Communications port
5	LV Global PG	Power Good signal for all modules
6	LV AC Fail	Primary fault status in which the modules must turn off
7	LV OTP	Warning that shutdown may occur due to over temperature
8	HV AC Fail	Primary fault status in which the cap charger output must turn off
9	Fan Fail	Primary fault status in which the fan fault has occurred must turn off
10	+5V Aux	Auxiliary output_B

FC2500 SERIES

INTERFACE

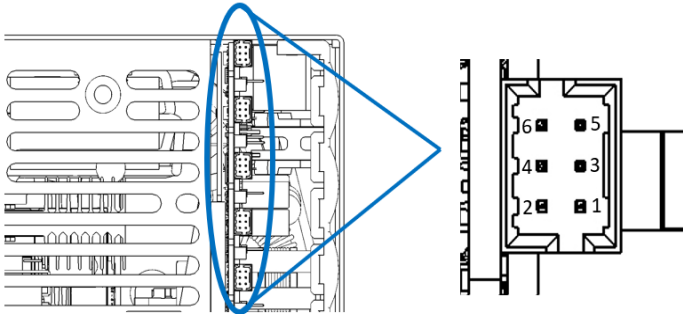

Connector J100m which controls slot n

Connector	Slot
J1001	A
J1002	B
J1003	C
J1004	D
J1005	E

Note: 'm' indicates 1, 2, 3, 4, 5;

'n' indicates A, B, C, D, E

Connector J100m which controls slot n		
Pin	Name	Function
1	Common	Common ground
2	PG	Power Good signal for module
3	Common	Common ground
4	EN	External global enable and disable module
5	Itrim	Connect voltage source to control level of current limit of module
6	Vtrim	Connect voltage source to control the output voltage level

Capacitor Charger Interface Connector

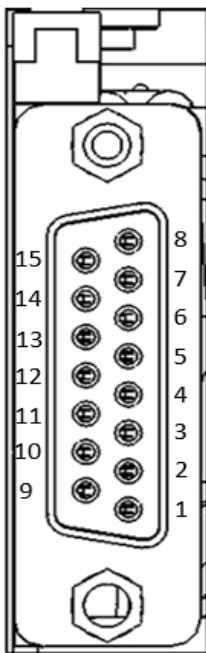

J3003

J3003 Connector		
Pin	Name	Function
1	Inhibit	Inhibit
2	Ptrim	Power limit adjustment
3	HV OTP	Over temperature warning
4	Imonitor	Output current sense signal
5	Vprogram	Output voltage setting
6	HV Fault	High voltage output fault detect
7	VPeakHold	Output voltage peak level
8	Vmonitor	Output voltage sense
9	+15V Aux	15 V, 3 W user bias supply
10	Not used	
11	+15V Aux	15 V, 3 W user bias supply
12	Not used	
13	End of Charge	End-of-Charge indicator
14	Earth	Earth
15	Enable	Enable

INTERFACE (CONTINUED)

CoolMod Connectors

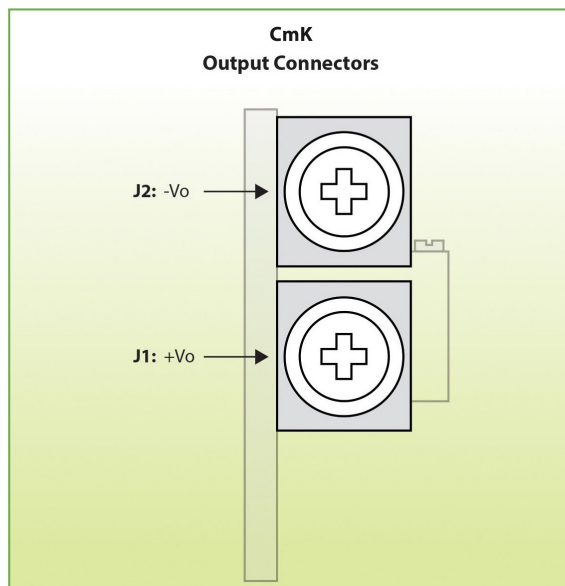
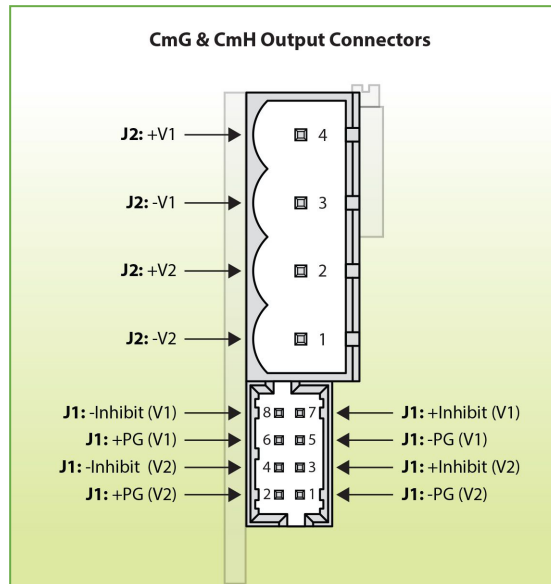
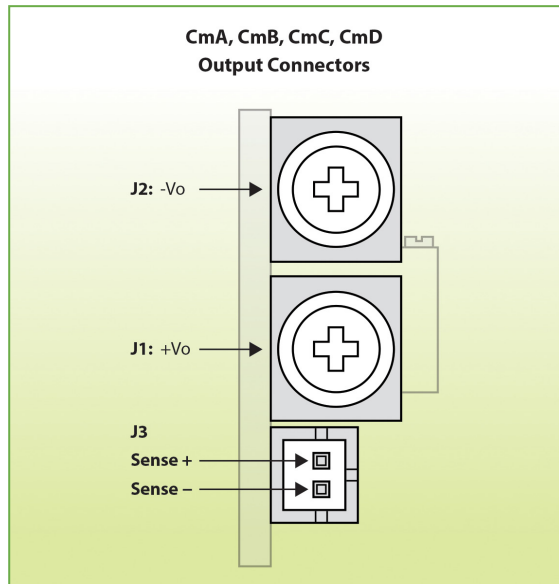

FC2500 SERIES

CONFIGURATION

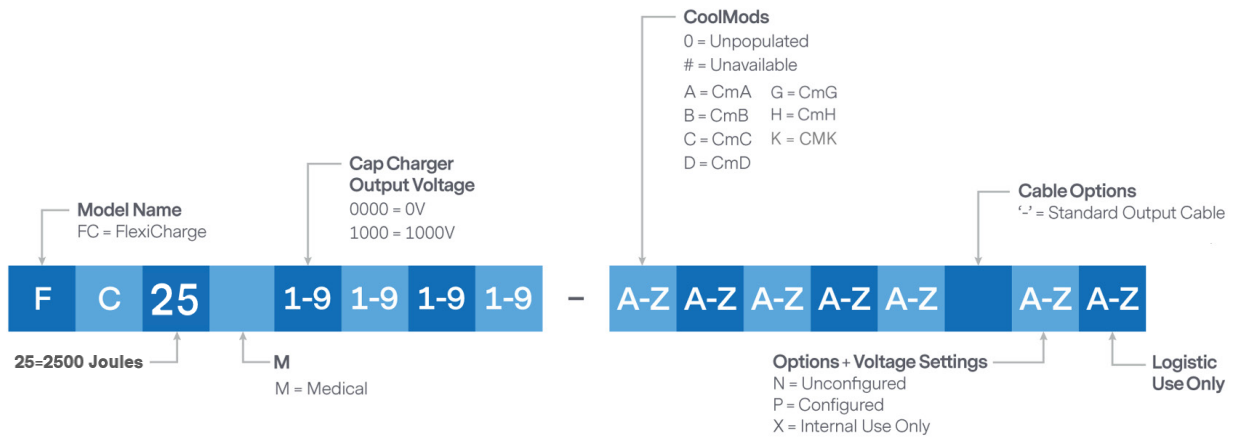

Configuration Example 1

Part number FC25M1000-ACCDH-P specifies the following product:

FC25M—2500 W IEC60601-1 approved

Max capacitor charge voltage: 700 Volts

Slot 1: CmA, 5 V/21 A module

Slot 2: CmC, 24 V/8.3 A module

Slot 3: CmC, 24 V/8.3 A module

Slot 4: CmD, 48 V/4.16 A module

Slot 5: CmH, 5 V/6 A and 24 V/3 A dual module

Option P: Preset required. Slot 2 and Slot 3 connected in parallel



For international contact information,
visit [advancedenergy.com](https://www.advancedenergy.com)

powersales@aei.com (Sales Support)
productsupport.ep@aei.com (Technical
Support)+1 888 412 7832

ABOUT ADVANCED ENERGY

Advanced Energy (AE) has devoted more than four decades to perfecting power for its global customers. AE designs and manufactures highly engineered, precision power conversion, measurement and control solutions for mission-critical applications and processes.

Our products enable customer innovation in complex applications for a wide range of industries including semiconductor equipment, industrial, manufacturing, telecommunications, data center computing, and medical. With deep applications know-how and responsive service and support across the globe, we build collaborative partnerships to meet rapid technological developments, propel growth for our customers, and innovate the future of power.

PRECISION | POWER | PERFORMANCE | TRUST

Specifications are subject to change without notice. Not responsible for errors or omissions. ©2024 Advanced Energy Industries, Inc. All rights reserved. Advanced Energy®, and AE® are U.S. trademarks of Advanced Energy Industries, Inc.

