



## 40W Single Output AC Dimmable LED Power Supply

## PCD-40 series



## ■ Features :

- AC phase-cut dimming
- Work with leading edge and trailing edge TRIAC dimmers
- Built-in active PFC function
- Constant current design
- Protections: Short circuit / Over temperature
- Cooling by free air convection
- Fully isolated plastic case
- IP42 design
- Class II power unit, no FG
- Suitable for LED related fixture or appliance (such as LED Decoration or Advertisement devices)
- 100% full load burn-in test
- Low cost
- High reliability
- 3 years warranty

User's Manual



## ■ GTIN CODE

MW Search: <https://www.meanwell.com/serviceGTIN.aspx>

## SPECIFICATION

MODEL	PCD-40-350B	PCD-40-500B	PCD-40-700B	PCD-40-1050B	PCD-40-1400B	PCD-40-1750B	
OUTPUT	RATED CURRENT	350mA	500mA	700mA	1050mA	1400mA	1750mA
	OPERATING VOLTAGE RANGE	70 ~ 108V	45 ~ 80V	34 ~ 57V	22 ~ 38V	17 ~ 29V	13 ~ 23V
	CURRENT ACCURACY	±5.0%					
	RATED POWER	37.8W	40W	39.9W	39.9W	40.6W	40.25W
	RIPPLE & NOISE (max.) Note.1	9.5Vp-p	5.0Vp-p	3.1Vp-p	2.6Vp-p	2.5Vp-p	2.4Vp-p
	NO LOAD OUTPUT VOLTAGE (max.)	118V	100V	63V	50V	35V	35V
SETUP TIME	500ms / 230VAC at full load						
INPUT	VOLTAGE RANGE	180~295VAC					
	FREQUENCY RANGE	47 ~ 63Hz					
	POWER FACTOR (Typ.)	PF>0.9/230VAC, PF>0.9/277VAC at full load (Please refer to "Power Factor Characteristic" curve)					
	TOTAL HARMONIC DISTORTION	THD< 20% when output loading≥60%(PCD-40-350B loading≥65%)at 230VAC input and output loading≥75% at 277VAC input					
	EFFICIENCY (Typ.)	87%	87%	86%	86%	85%	85%
	AC CURRENT (Typ.)	0.35A/230VAC 0.3A/277VAC					
	INRUSH CURRENT(Typ.)	COLD START 11A (twidth=50μs measured at 50% Ipeak) at 230VAC					
	MAX. No. of PSUs on 16A CIRCUIT BREAKER	47 units (circuit breaker of type B) / 47 units (circuit breaker of type C) at 230VAC					
LEAKAGE CURRENT	<0.5mA / 240VAC						
PROTECTION	SHORT CIRCUIT	Hiccup mode, recovers automatically after fault condition is removed.					
	OVER TEMPERATURE	Shut down o/p voltage, auto-recovery					
ENVIRONMENT	WORKING TEMP.	-30 ~ +50°C (Refer to "Derating Curve")					
	WORKING HUMIDITY	20 ~ 95% RH non-condensing					
	STORAGE TEMP., HUMIDITY	-40 ~ +80°C, 10 ~ 95% RH					
	TEMP. COEFFICIENT	±0.03%/°C (0 ~ 50°C)					
	VIBRATION	10 ~ 500Hz, 2G 12min./1cycle, period for 72min. each along X, Y, Z axes					
SAFETY & EMC	SAFETY STANDARDS	ENEC BS EN/EN61347-1, BS EN/EN61347-2-13 independent, BS EN/EN62384, EAC TP TC 004,IP42 approved					
	WITHSTAND VOLTAGE	I/P-O/P:3.75KVAC					
	ISOLATION RESISTANCE	I/P-O/P:100M Ohms / 500VDC / 25°C / 70% RH					
	EMC EMISSION	Compliance to BS EN/EN55015, BS EN/EN61000-3-2 Class C ; BS EN/EN61000-3-3, EAC TP TC 020					
	EMC IMMUNITY	Compliance to BS EN/EN61000-4-2,3,4,5,6,8,11, BS EN/EN61547, light industry level(Surge 2KV), criteria B, EAC TP TC 020					
OTHERS	MTBF	4038.1K hrs min. Telcordia SR-332 (Bellcore)		362.3Khrs min. MIL-HDBK-217F (25°C)			
	DIMENSION	128*60*31.5mm (L*W*H)					
	PACKING	0.23Kg;30pcs/7.9Kg/0.58CUFT					
NOTE	<ol style="list-style-type: none"> <li>1. Ripple &amp; noise are measured at 20MHz of bandwidth by using a 12" twisted pair-wire terminated with a 0.1uf &amp; 47uf parallel capacitor.</li> <li>2. Direct connecting to LEDs is suggested, but is not suitable for using additional drivers.</li> <li>3. To fulfill requirements of the latest ErP regulation for lighting fixtures, this LED power supply can only be used behind a switch without permanently connected to the mains.</li> <li>4. The ambient temperature derating of 3.5°C/1000m with fanless models and of 5°C/1000m with fan models for operating altitude higher than 2000m(6500ft).</li> <li>5. For any application note and IP water proof function installation caution, please refer our user manual before using. <a href="https://www.meanwell.com/Upload/PDF/LED_EN.pdf">https://www.meanwell.com/Upload/PDF/LED_EN.pdf</a></li> </ol> <p>※ Product Liability Disclaimer : For detailed information, please refer to <a href="https://www.meanwell.com/serviceDisclaimer.aspx">https://www.meanwell.com/serviceDisclaimer.aspx</a></p>						



40W Single Output AC Dimmable LED Power Supply

PCD-40 series

■ Mechanical Specification

Case No.:PCD40A Unit:mm

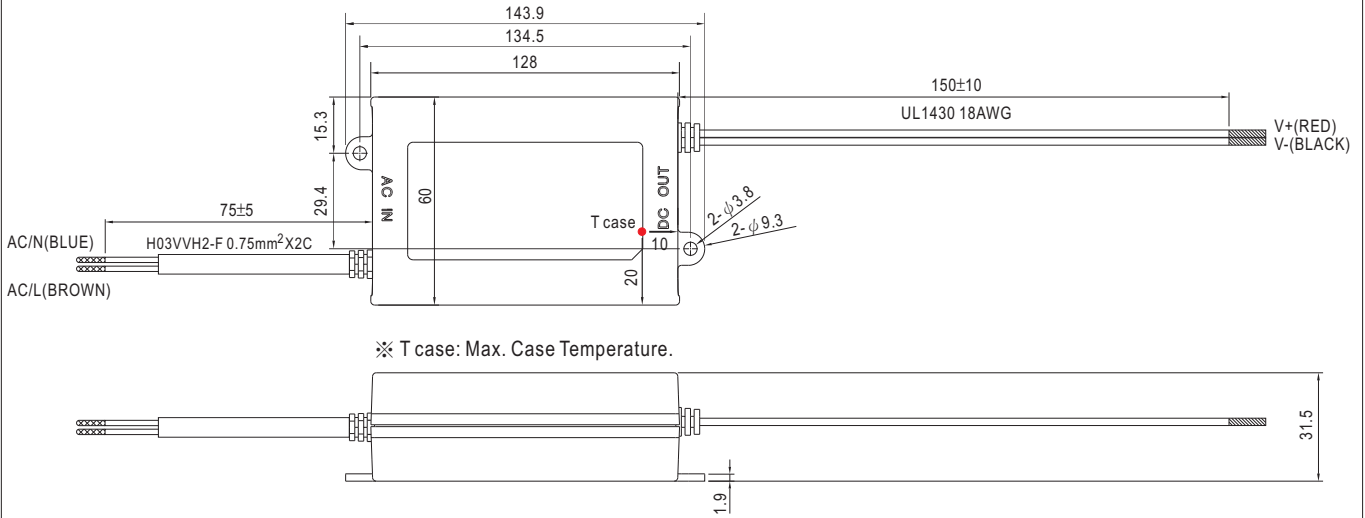

■ Block Diagram

fosc :60KHz(230VAC)

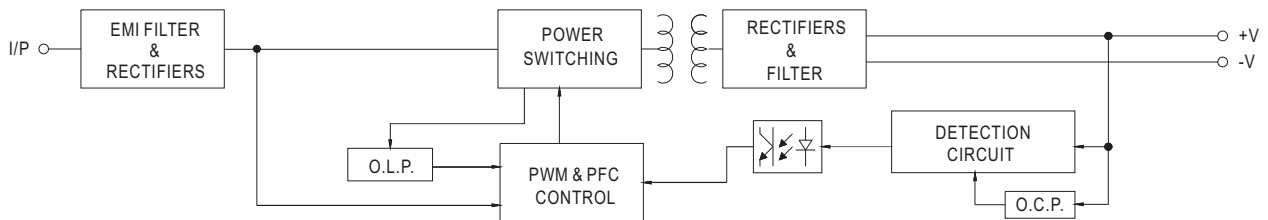

■ Derating Curve

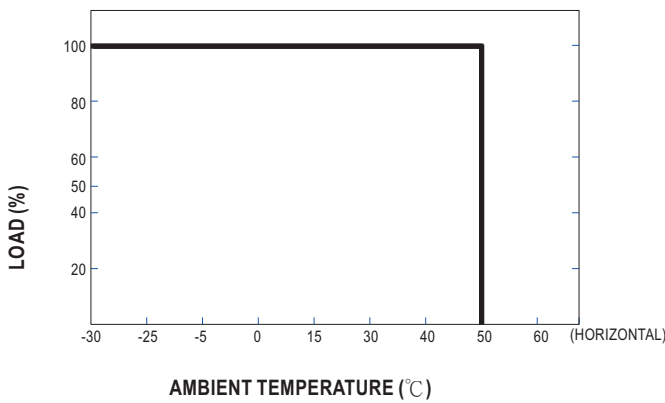

■ Static Characteristics

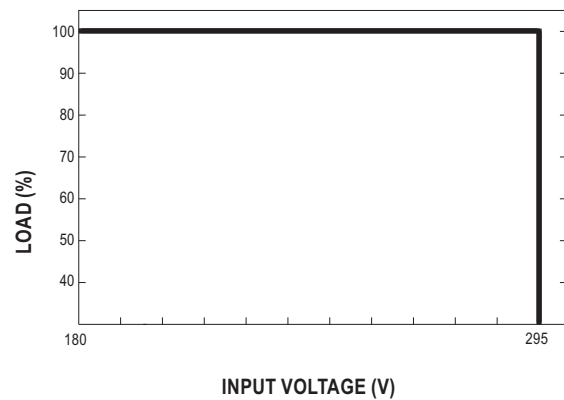



**Power Factor Characteristic**

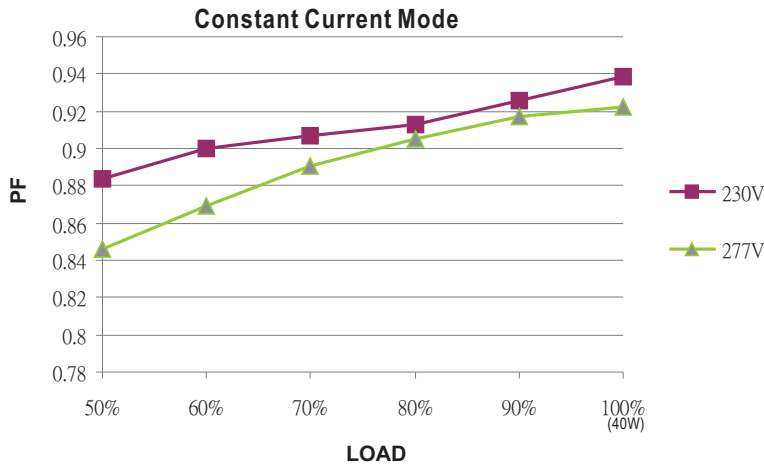

**EFFICIENCY vs LOAD (PCD-40-500B)**

PCD-40 series possess superior working efficiency that up to 87% can be reached in field applications.

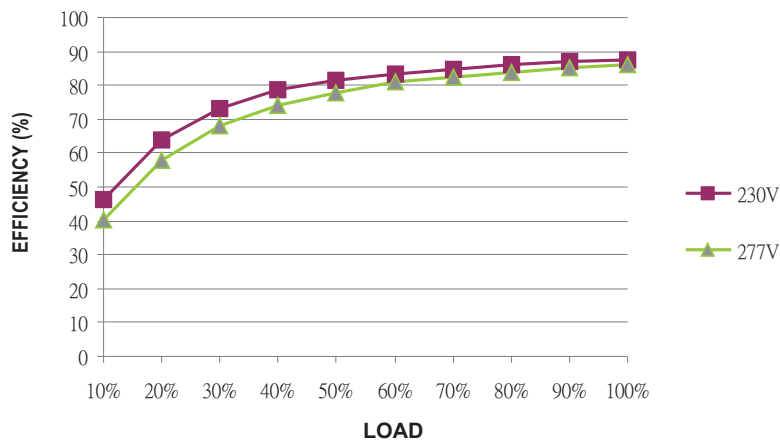



**AC Dimming Operation**

⊙ The following diagram depicts a typical installation utilizing the PCD-40 :

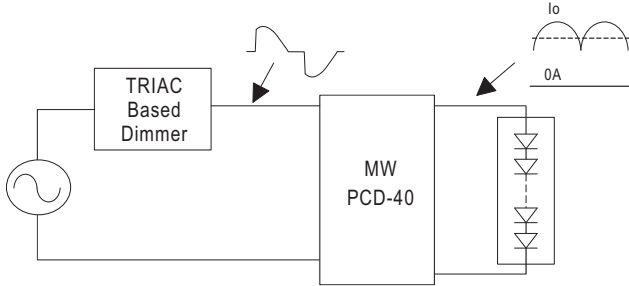

Under direct driving, the power supply will work in "constant current mode (CC)" and output voltage of the power supply will be clamped by sum of forward voltage (V<sub>F</sub>) of the LED strip.

⊙ Dimmer Compatibility Chart

Manufacturer	Dimmer Model	
LUTRON	SKYLARK SF-12P-277	(277VAC / 60Hz)
LUTRON	DVF-103P-277	(277VAC / 60Hz)
JUNG	Licht-Management 225 TDE	(230VAC / 50Hz)
JUNG	Licht-Management 225 NV DE	(230VAC / 50Hz)
BERKER	Tronic-Drehdimmer 286710	(230-240VAC / 50Hz)
CLIPSAL	32E450UDM	(220-240VAC / 50Hz)
CLIPSAL	NO 32E450TM	(220-240VAC / 50Hz)
CLIPSAL	NO 32E450LM	(220-240VAC / 50Hz)
CLIPSAL	Cat 400T	(230-240VAC / 50Hz)

Conduction angle: 30 degrees(min.) / 180 degrees(max.)