



60W Multiple-Stage Constant Power/Constant Voltage LED Driver

XLN-60 series



(Independent type)



■ Features

- Constant power mode output with multiple stage selectable by NFC setting (H-type)
- Constant voltage mode output available(12/24/48V)
- Plastic housing with class II and PFC design
- Meet UL8750 Class 2 / Class P power unit
- Flicker free, complying with CE ErP directive
- Standby power consumption <0.5W
- Meet emergency lighting (EL) application
- Fully encapsulated with IP67
- Minimum dimming level 0.1% (DALI-2 DT6)
- Dimming functions: 3 in 1 dimming (Dim-to-off) DALI-2 + Push dimming
- 5 years warranty

■ Applications

- Recessed Light
- Down Light
- Panel Light
- Commercial Lighting
- Decorative Lighting
- LED strip lighting
- DALI digital Lighting

■ GTIN CODE

MW Search: <https://www.meanwell.com/serviceGTIN.aspx>

■ Description

XLN-60 Series is a 60W with constant power and constant voltage output LED driver . It can operate from 110~305V AC and output current ranging between 900 mA to 1700 mA selectable by NFC setting. Thanks to high efficiency up to 90%, it is able to operate for -25°C~90°C case temperature under free air convection. XLN-60 is designed based on latest safety regulation with 3 in 1 and DALI-2 dimming. XLN-60 can be adjusted for brightness with a push button as a simple way dimming, so it provides more flexibility for LED Lighting application.

■ Model Encoding

XLN - 60 - H - □

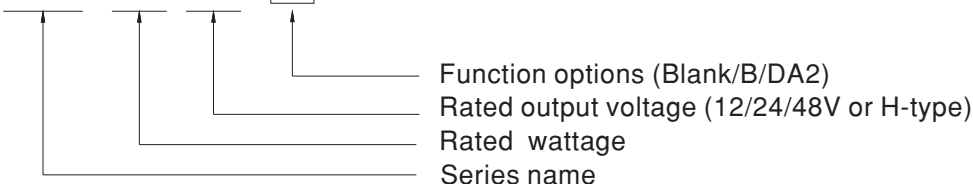

| Type | Function | Note |
|-------|--|----------|
| Blank | H type output current selectable by NFC setting with constant power mode 12, 24, 48V Constant voltage output | In stock |
| B | H type output current selectable by NFC setting and built-in 3 in 1 dimming 12, 24, 48V Constant voltage output and built-in 3 in 1 Dimming(PWM Style output) | |
| DA2 | H type output current selectable by NFC setting and built-in DALI-2 dimming 12, 24, 48V Constant voltage output and built-in DALI-2(PWM Style output) | |

Note: 1. 12/24/48V output is fixed without NFC Function.
2. For more current setting, please contact MW sales representative.



SPECIFICATION

| MODEL | | XLN-60-12-□ | XLN-60-24-□ | XLN-60-48-□ |
|-------------|---|--|---|---------------------|
| OUTPUT | DC VOLTAGE | 12V | 24V | 48V |
| | DEFAULT CURRENT | 5A | 2.5A | 1.25A |
| | RATED POWER | 60W | 60W | 60W |
| | SETUP,RISE TIME | 800ms,180ms/230VAC ,1000ms,180ms/115VAC | | |
| INPUT | VOLTAGE RANGE | 110~305VAC 155~400VDC | | |
| | FREQUENCY RANGE | 47 ~ 63Hz | | |
| | POWER FACTOR | PF ≥ 0.95/115VAC, PF ≥ 0.95/230VAC, PF ≥ 0.9/277VAC@full load (Please refer to "POWER FACTOR (PF) CHARACTERISTIC" section) | | |
| | TOTAL HARMONIC DISTORTION | THD < 20%(@load ≥ 50%/230VAC; @load ≥ 75%/277VAC), THD < 10%(@load 100%/230VAC, THD < 10%@Load 100%/115VAC (Please refer to "TOTAL HARMONIC DISTORTION(THD)" section) | | |
| | EFFICIENCY(Typ.) | 86% | 87% | 88% |
| | AC CURRENT | 0.75A/115VAC, 0.35A/230VAC, 0.3A/277VAC | | |
| | INRUSH CURRENT | COLD START 15A(twidth=310μs measured at 50% Ipeak) at 230VAC; Per NEMA 410 | | |
| | MAX. NO. of PSUs on 16A CIRCUIT BREAKER | 25 units (circuit breaker of type B) / 36 units (circuit breaker of type C) at 230VAC | | |
| | LEAKAGE CURRENT | <0.75mA / 277VAC | | |
| | STANDBY POWER CONSUMPTION | Note5 Note8 | Standby power consumption<0.5W(Dimming OFF, only for standard version B/DA2-type) | |
| PROTECTION | OVERLOAD | 105~180% rated output power Protection type: Hiccup mode, recovers automatically after fault condition is removed. | | |
| | SHORT CIRCUIT | Hiccup mode, recovers automatically after fault condition is removed | | |
| | OVER VOLTAGE | 14-17V | 26-35V | 52-63V |
| | | Shut down output voltage, re-power on to recover | | |
| | OVER TEMPERATURE | Shut down output voltage, recovers automatically after fault condition is removed | | |
| ENVIRONMENT | WORKING TEMP. | Tcase=-25~90℃ (Please refer to "OUTPUT LOAD vs TEMPERATURE" section) | | |
| | MAX. CASE TEMP. | Tcase=90℃ | | |
| | WORKING HUMIDITY | 20 ~ 90% RH non-condensing | | |
| | STORAGE TEMP.,HUMIDITY | -40 ~ +80℃, 10 ~ 95% RH | | |
| | TEMP. COEFFICIENT | ±0.03%/℃ (0 ~ 50℃) | | |
| | VIBRATION | 10 ~ 500Hz, 2G 10min./1cycle, period for 60min. each along X, Y, Z axes | | |
| SAFETY&EMC | SAFETY STANDARDS | UL8750(type "HL" and Class P),CSA C22.2 No. 250.13-12;ENEC BS EN/EN61347-1, BS EN/EN61347-2-13(EL) appendix J suitable for emergency installations(DC input 176-280VDC); BS EN/EN62384 independent, GB19510.14, GB19510.1, EAC TP TC 004 approved; Design refer to AS/NZS 61347-1, AS/NZS 61347-2-13 | | |
| | DALI STANDARDS | Comply with IEC62386-101, 102, 207 | | |
| | WITHSTAND VOLTAGE | I/P-O/P:3.75KVAC | | |
| | ISOLATION RESISTANCE | I/P-O/P:>100M Ohms / 500VDC / 25℃ / 70% RH | | |
| | EMC EMISSION | BS EN/EN55015, BS EN/EN61000-3-2 Class C; BS EN/EN61000-3-3; GB 17625.1,GB/T 17743, EAC TP TC 020 | | |
| | EMC IMMUNITY | BS EN/EN61000-4-2,3,4,5,6,8,11, BS EN/EN61547, light industry level(surge immunity Line-Line 1KV), EAC TP TC 020 | | |
| OTHERS | FLICKER | Note.9 | PstLM ≤ 1, SVM ≤ 0.4 | |
| | MTBF | 4053.7K hrs min. Telcordia SR-332 (Bellcore) | 329.4Khrs min. | MIL-HDBK-217F (25℃) |
| | DIMENSION | 141.5*49*32mm(L*W*H) | | |
| | PACKING | 0.49Kg ; 30pcs/15.7Kg/0.81CUFT | | |
| NOTE | <p>1. All parameters NOT specially mentioned are measured at 230VAC input, rated current and 25℃ of ambient temperature.</p> <p>2. De-rating may be needed under low input voltages. Please refer to "STATIC CHARACTERISTIC" sections for details.</p> <p>3. Length of set up time is measured at first cold start. Turning ON/OFF the driver may lead to increase of the set up time.</p> <p>4. Current ripple is measured 50%~100% of maximum voltage under rated power delivery.</p> <p>5. Standby power consumption is measured at 230VAC.</p> <p>6. The driver is considered as a component that will be operated in combination with final equipment. Since EMC performance will be affected by the complete installation, the final equipment manufacturers must re-qualify EMC Directive on the complete installation again. (as available on https://www.meanwell.com/Upload/PDF/EMI_statement_en.pdf)</p> <p>7. The ambient temperature derating of 3.5℃/1000m with fanless models and of 5℃/1000m with fan models for operating altitude higher than 2000m(6500ft).</p> <p>8. To fulfill requirements of the latest ErP regulation for lighting fixture, this LED driver can only be used behind a switch without permanently connected to the mains.</p> <p>9. Flicker is measured at full load with LED strip.</p> <p>10. RCM is on a voluntary basis. Non IC classification Independent LED control gear is not suitable for residential installations.</p> <p>11.This series meets the typical life expectancy of 50000 hours of operation when Tcase,particularly tc point(or TMP,per DLC), is about 75℃ or less.</p> <p>12. For more information, please contact with MEAN WELL sales.</p> <p>※ Product Liability Disclaimer : For detailed information , please refer to https://www.meanwell.com/serviceDisclaimer.aspx</p> | | | |



SPECIFICATION

| MODEL | | XLN-60-H-□ |
|---------------------------------------|--|--|
| OUTPUT | OPEN CIRCUIT VOLTAGE <small>Note14</small> | 60V |
| | DEFAULT CURRENT | 1400mA |
| | CURRENT ADJ. RANGE (BY NFC) | 0.9~1.7A |
| | CONSTANT CURRENT REGION | 9~54V |
| | RATED POWER | 60W |
| | CURRENT RIPPLE <small>Note4</small> | <4% |
| | CURRENT TOLERANCE | ±5% |
| | DIMMING RANGE | 0~100% |
| SETUP,RISE TIME <small>Note13</small> | 800ms,100ms/230VAC ,1000ms,100ms/115VAC | |
| INPUT | VOLTAGE RANGE | 110~305VAC 155~400VDC |
| | FREQUENCY RANGE | 47 ~ 63Hz |
| | POWER FACTOR | PF ≥ 0.95/115VAC, PF ≥ 0.95/230VAC, PF ≥ 0.9/277VAC@full load (Please refer to "POWER FACTOR (PF) CHARACTERISTIC" section) |
| | TOTAL HARMONIC DISTORTION | THD < 20%(@load ≥ 50%/230VAC; @load ≥ 75%/277VAC), THD < 10%@load 100%/230VAC, THD < 10%@Load 100%/115VAC (Please refer to "TOTAL HARMONIC DISTORTION(THD)" section) |
| | EFFICIENCY(Typ.) <small>Note12</small> | 90% |
| | AC CURRENT | 0.75A/115VAC, 0.35A/230VAC, 0.3A/277VAC |
| | INRUSH CURRENT | COLD START 15A(twidth=310μs measured at 50% Ipeak) at 230VAC; Per NEMA 410 |
| | MAX. NO. of PSUs on 16A CIRCUIT BREAKER | 25 units (circuit breaker of type B) / 36 units (circuit breaker of type C) at 230VAC |
| | LEAKAGE CURRENT | <0.75mA / 277VAC |
| | STANDBY POWER CONSUMPTION <small>Note5</small> <small>Note8</small> | Standby power consumption < 0.5W (Dimming off, only for standard version B/DA2-type) |
| PROTECTION | SHORT CIRCUIT | Hiccup mode, recovers automatically after fault condition is removed |
| | OVER TEMPERATURE | DA2 type: Stage 1: Derating to 75% loading; stage2: Derating to 50% loading; Recovers automatically after fault condition is removed Blank & B type: Derating to lowest output level, Recovers automatically after fault condition is removed |
| ENVIRONMENT | WORKING TEMP. | Tcase=-25~90°C (Please refer to "OUTPUT LOAD vs TEMPERATURE" section) |
| | MAX. CASE TEMP. | Tcase=90°C |
| | WORKING HUMIDITY | 20 ~ 90% RH non-condensing |
| | STORAGE TEMP., HUMIDITY | -40 ~ +80°C, 10 ~ 95% RH |
| | TEMP. COEFFICIENT | ±0.03%/°C (0 ~ 50°C) |
| VIBRATION | 10 ~ 500Hz, 2G 10min./1cycle, period for 60min. each along X, Y, Z axes | |
| SAFETY&EMC | SAFETY STANDARDS | UL8750(type"HL" and Class P),CSA C22.2 No. 250.13-12; ENEC BS EN/EN61347-1, BS EN/EN61347-2-13(EL) appendix J suitable for emergency installations(DC input 176-280VDC); BS EN/EN62384 independent, GB19510.14, GB19510.1, EAC TP TC 004 approved; Design refer to AS/NZS 61347-1, AS/NZS 61347-2-13 |
| | DALI STANDARDS | Comply with IEC62386-101, 102, 207 |
| | WITHSTAND VOLTAGE | I/P-O/P:3.75KVAC |
| | ISOLATION RESISTANCE | I/P-O/P:>100M Ohms / 500VDC / 25°C / 70% RH |
| | EMC EMISSION | BS EN/EN55015, BS EN/EN61000-3-2 Class C; BS EN/EN61000-3-3; GB 17625.1,GB/T 17743, EAC TP TC 020 |
| EMC IMMUNITY | BS EN/EN61000-4-2,3,4,5,6,8,11, BS EN/EN61547, light industry level(surge immunity Line-Line 1KV), EAC TP TC 020 | |
| OTHERS | FLICKER <small>Note9</small> | PstLM ≤ 1, SVM ≤ 0.4 |
| | MTBF | 4053.7Khrs min. Telcordia SR-332 (Bellcore) 329.4Khrs min. MIL-HDBK-217F (25°C) |
| | DIMENSION | 141.5*49*32mm (L*W*H) |
| | PACKING | 0.49Kg ; 30pcs/15.7Kg/0.81CUFT |
| NOTE | <p>1. All parameters NOT specially mentioned are measured at 230VAC input, rated current and 25°C of ambient temperature.</p> <p>2. De-rating may be needed under low input voltages. Please refer to "STATIC CHARACTERISTIC" sections for details.</p> <p>3. Length of set up time is measured at first cold start. Turning ON/OFF the driver may lead to increase of the set up time.</p> <p>4. Current ripple is measured 50%~100% of maximum voltage under rated power delivery.</p> <p>5. Standby power consumption is measured at 230VAC.</p> <p>6. The driver is considered as a component that will be operated in combination with final equipment. Since EMC performance will be affected by the complete installation, the final equipment manufacturers must re-qualify EMC Directive on the complete installation again. (as available on https://www.meanwell.com/Upload/PDF/EMI_statement_en.pdf)</p> <p>7. The ambient temperature derating of 3.5°C/1000m with fanless models and of 5°C/1000m with fan models for operating altitude higher than 2000m(6500ft).</p> <p>8. To fulfill requirements of the latest ErP regulation for lighting fixture, this LED driver can only be used behind a switch without permanently connected to the mains.</p> <p>9. Flicker is measured at full load with LED modules.</p> <p>10. RCM is on a voluntary basis. Non IC classification Independent LED control gear is not suitable for residential installations.</p> <p>11. This series meets the typical life expectancy of 50000 hours of operation when Tcase, particularly tc point(or TMP, per DLC), is about 75°C or less.</p> <p>12. Efficiency is measured at 1050mA/54V output set by DIP switch.</p> <p>13. Based on IEC 62386-101/102 DALI power on timing and interruption regulations, the set up time needs to test with a DALI controller which can support for DALI power on function, otherwise the start up time will be higher than 0.5 second.</p> <p>14. Output hiccups under no-load condition.(only for H-type).</p> <p>15. For more information, please contact with MEAN WELL sales.</p> <p>※ Product Liability Disclaimer : For detailed information, please refer to https://www.meanwell.com/serviceDisclaimer.aspx</p> | |



■ BLOCK DIAGRAM

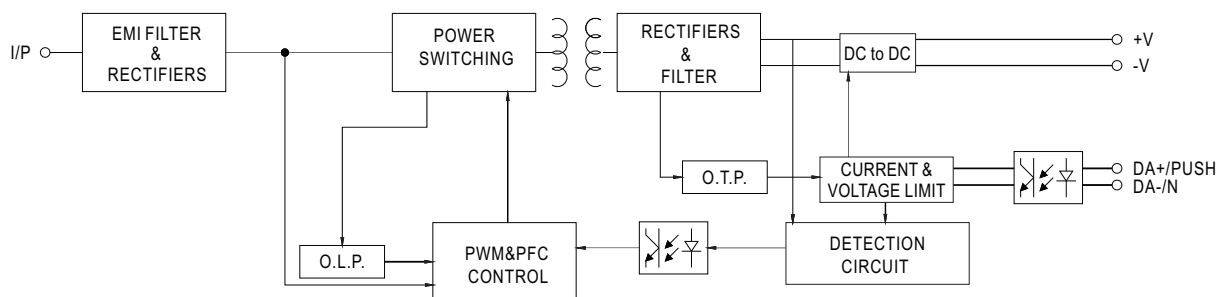

■ DRIVING METHODS OF LED MODULE

※ I-V Operating Area

◎ XLN-60-H

For 60W application

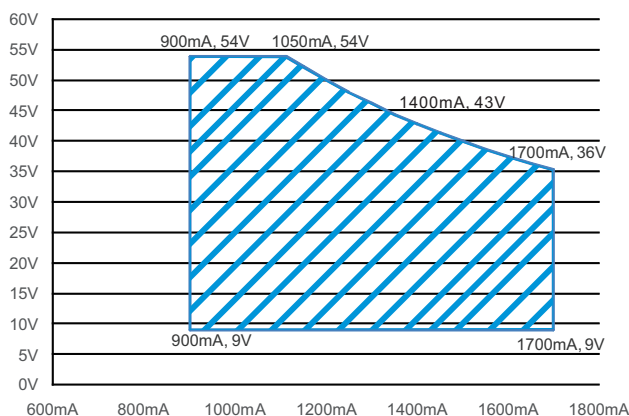

■ CONSTANT POWER TABLE

XLN-60-H is a multiple-stage constant power driver, selection of output current through NFC setting is exhibited below.

| Vo | Io |
|-------|-----------------|
| 9~54V | 900mA |
| 9~54V | 1050mA |
| 9~50V | 1200mA |
| 9~46V | 1300mA |
| 9~43V | 1400mA(default) |
| 9~40V | 1500mA |
| 9~38V | 1600mA |
| 9~36V | 1700mA |

Note: 1. The operating voltage range which show on this table is recommend to use.



NFC Function Description

The output current of the NFC Mode LED driver can be adjusted using NFC via the mobile APP

Operation Instruction:

- Compatible phone
 - Install an NFC-compatible smart mobile device or phone with Android™ 4.1 or IOS12 updates.
- Steps for setting output current via NFC
 1. Download Meanwell APP on mobile device or mobile phone, and enable NFC function.
 2. Check the NFC antenna position of the mobile phone please.
 3. Enter Meanwell APP ->Top left menu –Installation Manual/APP->PowerNFC, approach the LED driver NFC sensing position and perform sensing.
 4. APP displays the functional parameters, and the relevant parameters are modified as required.
 5. Tap the APP write button and quickly move the phone antenna close to the NFC sensing position of the LED driver.
 6. The write completes when the mobile phone displays"Success".

APP Function Description

※ APP Interface:

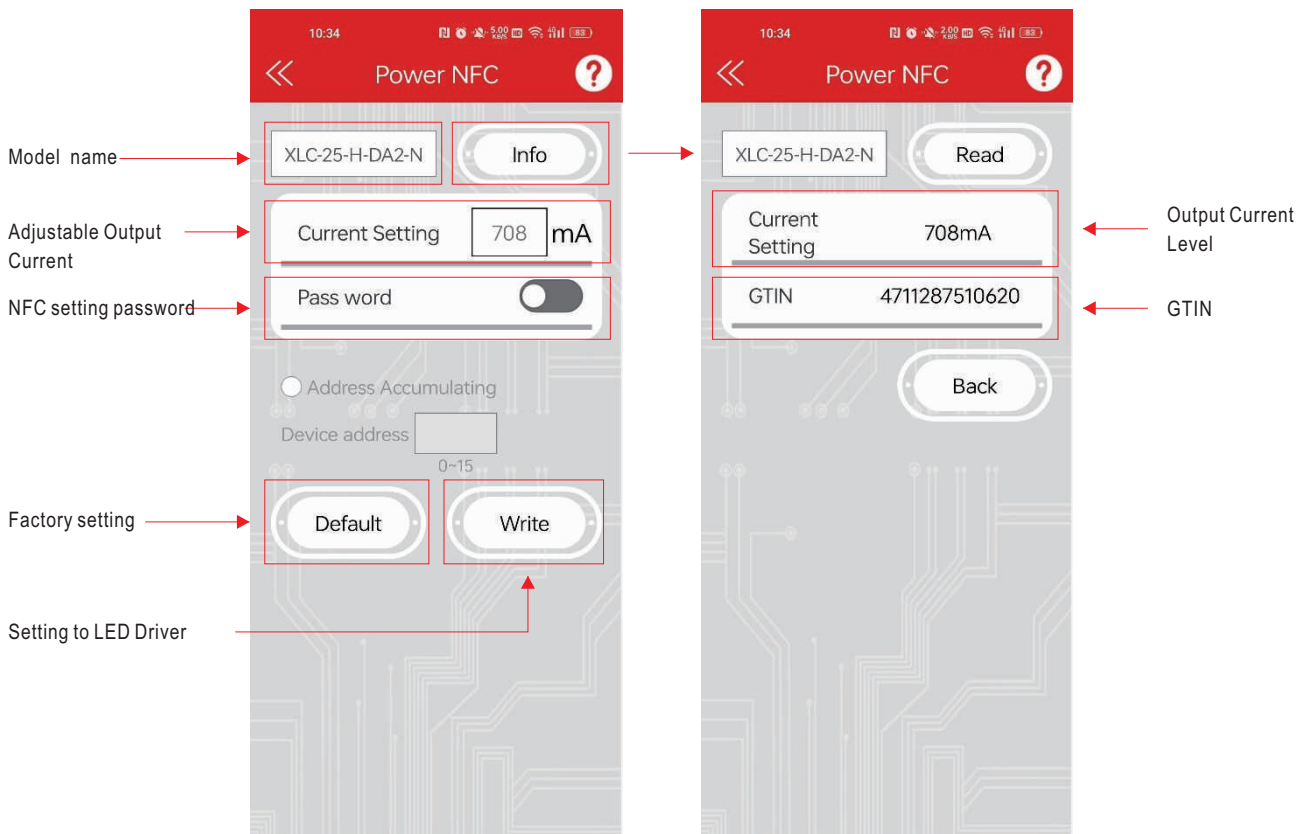

- To be used through APP available on Apple Store and Google Play Store for iOS and Android, Search 'MEAN WELL' on



Note: Current accuracy: the numerical error between the set current and the actual current is within 2%.



■ DIMMING OPERATION

◎ **B type**

※ **3 in 1 dimming function**

- Output constant current level can be adjusted by applying one of the three methodologies between DIM+ and DIM-: 0 ~ 10VDC, or 10V PWM signal or resistance.
- Direct connecting to LEDs is suggested. It is not suitable to be used with additional drivers.
- Dimming source current from power supply: 100 μ A (typ.)

◎ Applying additive 0 ~ 10VDC

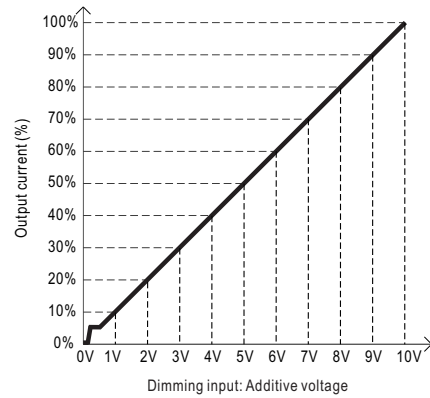
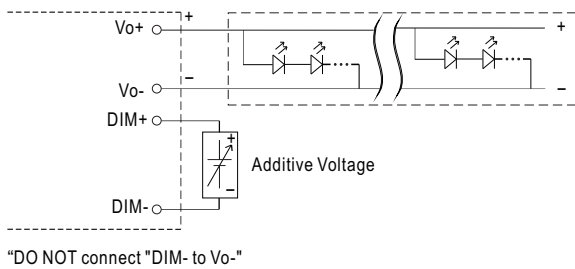

◎ Applying additive 10V PWM signal (frequency range 100Hz ~ 3KHz):

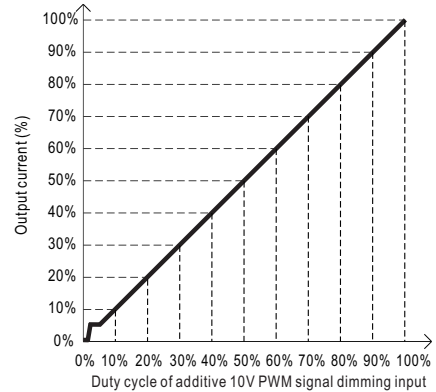
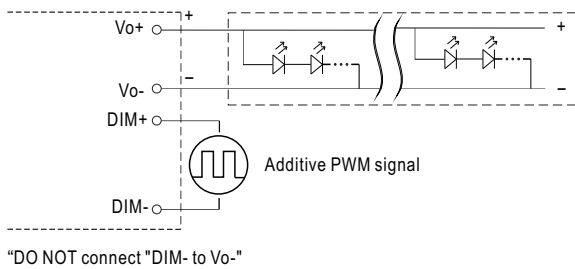

◎ Applying additive resistance: 0~100k Ω

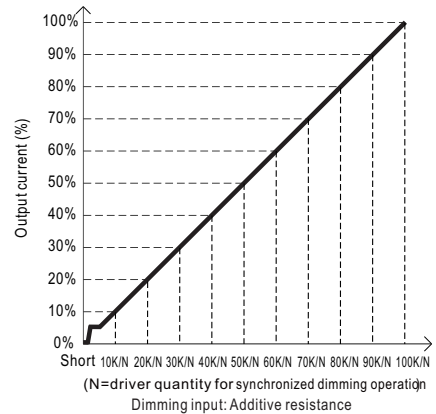
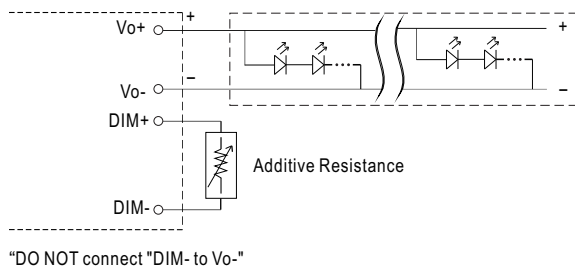

Note : 1. Min. dimming level is about 8% and the output current is not defined when 0% < Iout < 8%.
 2. The output current could drop down to 0% when dimming input is about 0k Ω or 0Vdc, or 10V PWM signal with 0% duty cycle.

■ DIMMING OPERATION

◎ DA2 type (DALI-2 digital dimming function)

※ Input wiring diagram

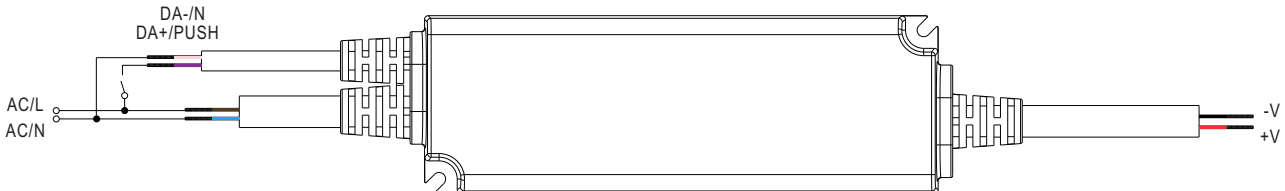

※ PUSH dimming (primary side)

- The factory default dimming level is at 100%.
- If the push action lasts less than 0.05 sec., it will not lead to a change for the status of the driver.
- Up to 10 drivers can perform the PUSH dimming at the same time when utilizing one common push button.
- The maximum length of the cable from the push button to the last driver is 20 meters.

| Action | Action duration | Function |
|--------------|---------------------|---|
| Short Push | 0.1~1s | Turn ON-OFF the driver |
| Double Click | Click twice in 1.5s | Set up the dimming level to 100% |
| Long Push | 1.5~10s | Every Long Push changes the dimming direction, dimming up or down |

■ PWM OUTPUT DIMMING PRINCIPLE

※ For 12V/24V/48V PWM style output dimming

- Dimming is achieved by varying the duty cycle of the output current.

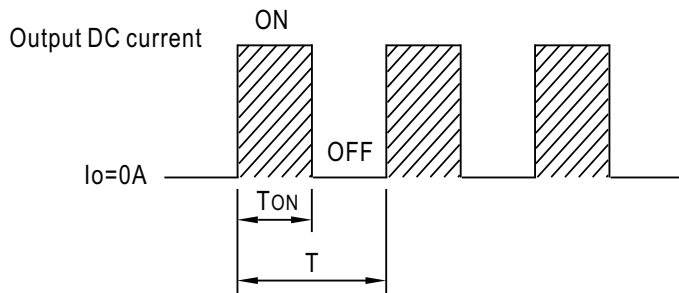

$$\text{Duty cycle(\%)} = \frac{T_{ON}}{T} \times 100\%$$

Output PWM frequency :
 4kHz for B-Type fixed (Typ.)
 3.2kHz for DA2-Type fixed (Typ.)



OUTPUT LOAD vs TEMPERATURE

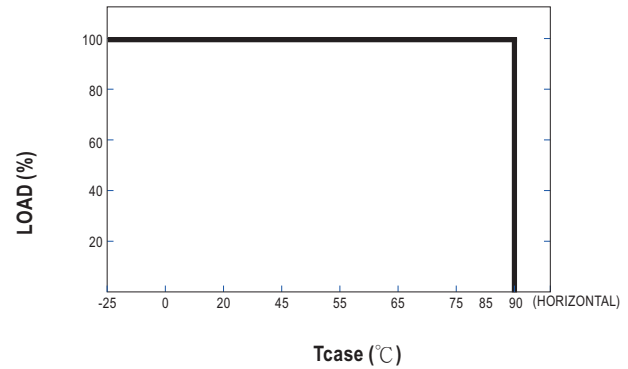
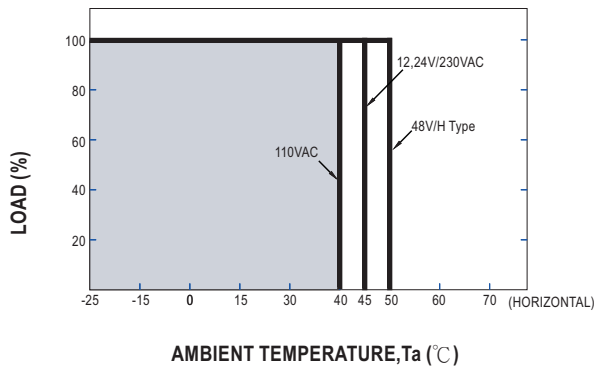

STATIC CHARACTERISTIC

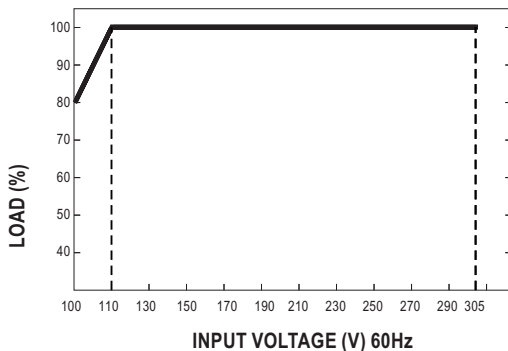

※ De-rating is needed under low input voltage.

LIFE TIME

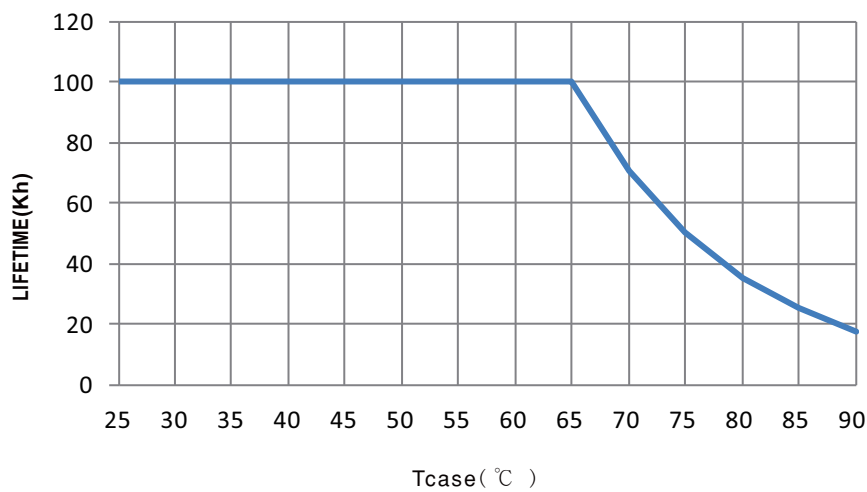



TOTAL HARMONIC DISTORTION (THD)

※ Tcase at 75°C

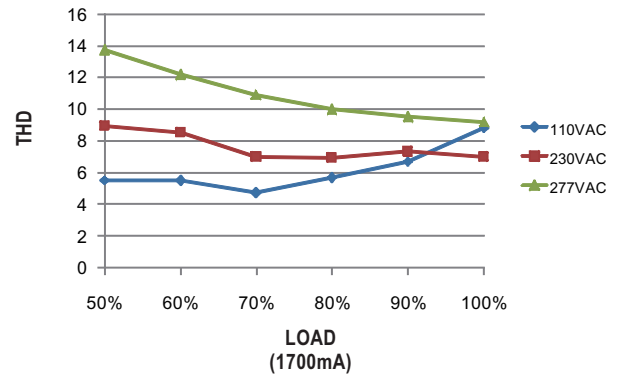
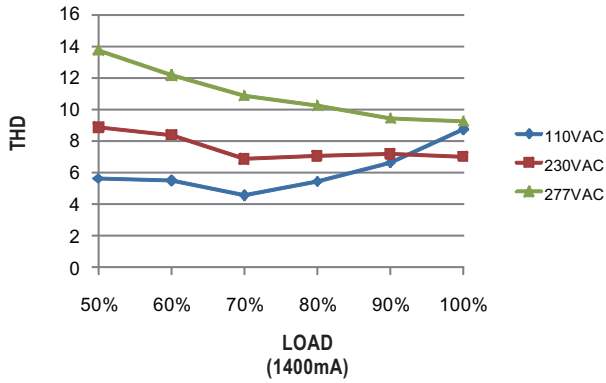

POWER FACTOR (PF) CHARACTERISTIC

※ Tcase at 75°C

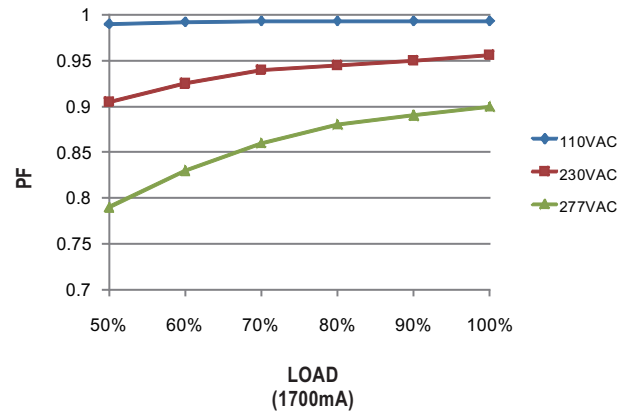
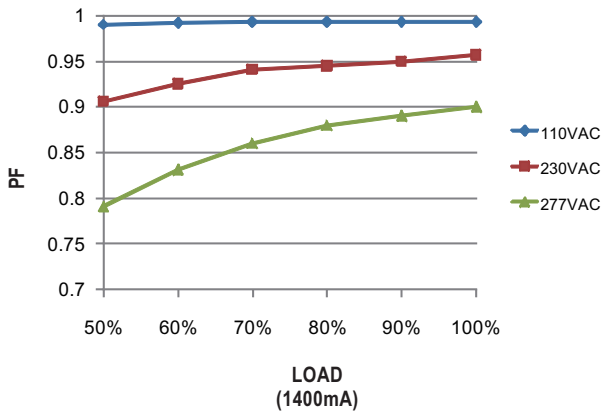

EFFICIENCY vs LOAD

XLN-60 series possess superior working efficiency that up to 90% can be reached in field applications.

※ Tcase at 75°C

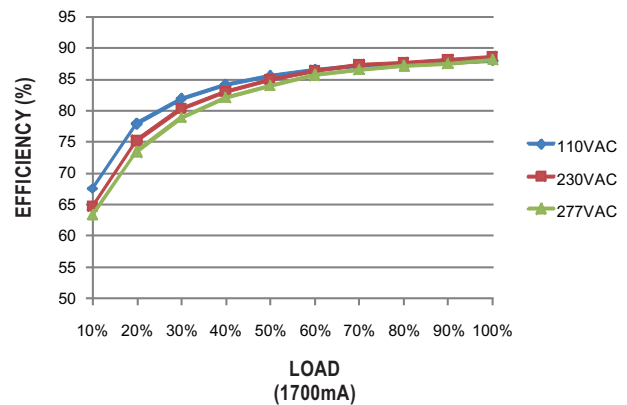
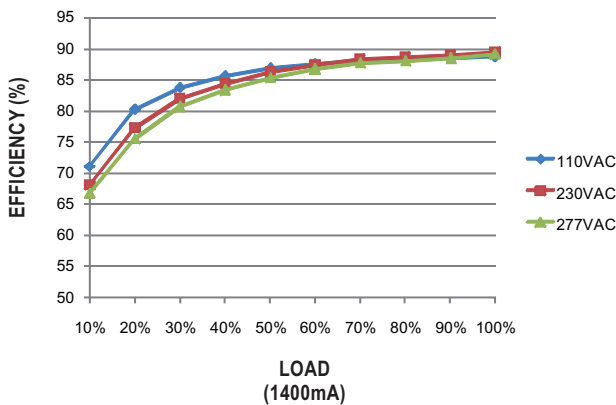



60W Multiple-Stage Constant Power/Constant Voltage LED Driver

XLN-60 series

MECHANICAL SPECIFICATION

Case No. XLN-60 Unit: mm

※ Blank type

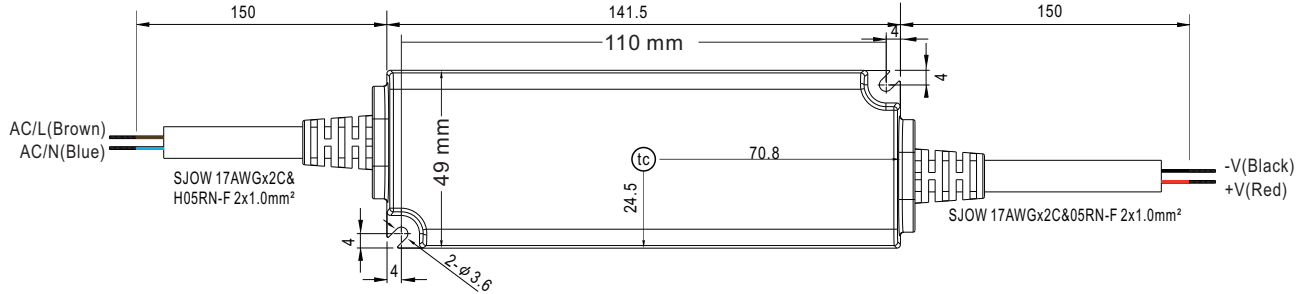

※ B type

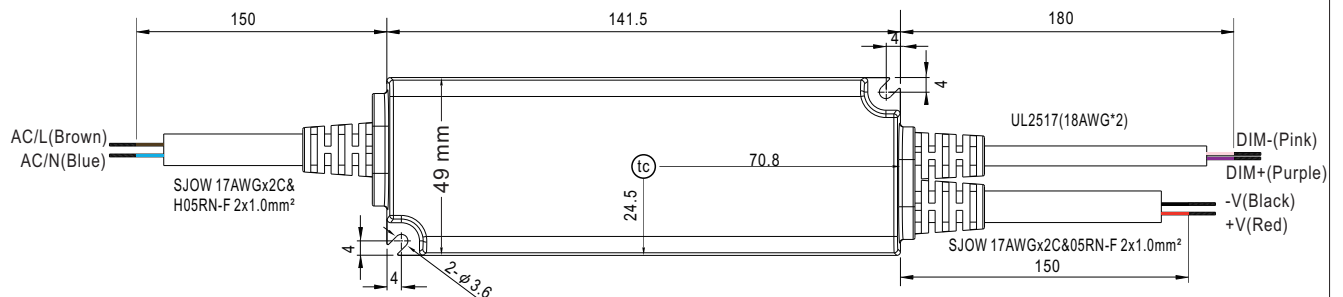

※ DA2 type

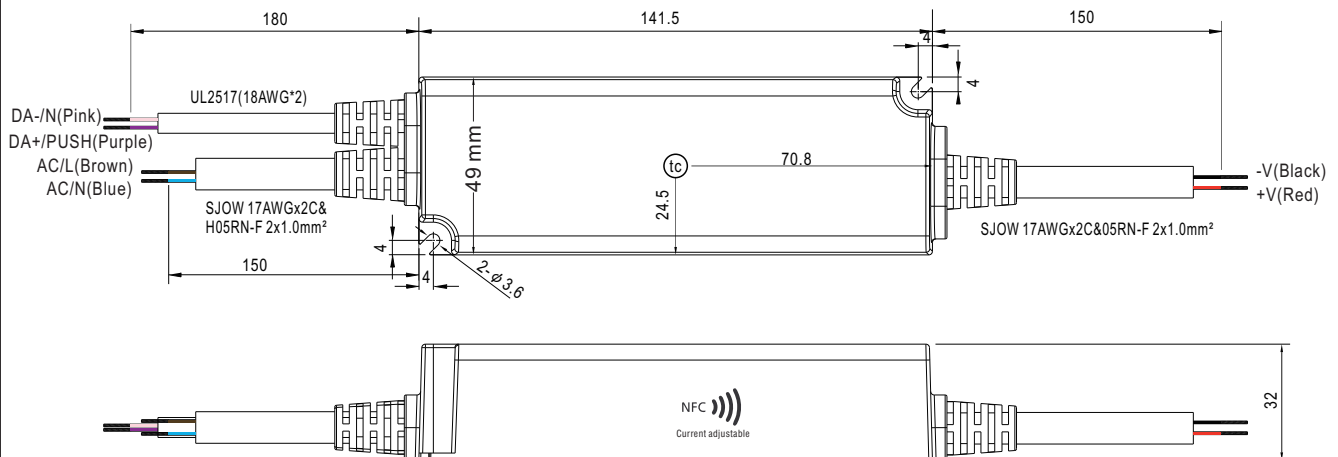

Installation Manual

Please refer to : <http://www.meanwell.com/manual.html>