



5KW True Sine Wave Inverter with AC Charger / UPS

NTN-5K series



AC output side



DC input side



Features

- Combining AC/DC charger, DC/AC Inverter, AC by-pass & support external MPPT solar charger
- AC utility charger up to 4520W
- UPS function (AC by-pass) without interruption, transfer time <10ms
- True sine wave output (THD<3%)
- High surge power up to 10KW
- Parallel synchroized operation up to 30KW (5+1 unit)
- Temperature controlled cooling fan
- AC output voltage and frequency selectable by DIP S.W
- Protections :
Input : Reverse polarity / DC low alarm / DC low shutdown / Over voltage
Output : Short circuit / Overload / Over temp.
- Battery over discharge protection (low voltage disconnect)
- -30°C ~+70°C wide operating temperature
- Suitable for lead-acid or li-ion batteries
- Support MODBus-RTU(RS-485) or CANBus protocol communication
- Graphical user interface controller CMU2E/CMU2E-R for status monitoring and control
- Conformal coating
- 5 years warranty

Applications

- Home and office appliance
- Power tools
- Portable equipment
- Vehicle
- Yacht
- Off-grid solar power system
- Wireless network
- Telecom or datacom system

GTIN CODE

MW Search: <https://www.meanwell.com/serviceGTIN.aspx>

Description

NTN-5K is a 5KW highly reliable off-grid true sine wave DC-AC power inverter with built-in AC charger and UPS function(AC by-pass). Its key features include: digital design with MCU control, streamlined control circuitry that quickly responds to environmental changes and improves reliability, high quality fan with low acoustic noise, 10KW peak power, adjustable AC output voltage and frequency, -30~+70°C wide. Operating temperature range, complete protection features, and etc. Combined with batteries, the NTN-5K is suitable for use in residential, commercial, marine, automobile, mine, construction site, and remote areas with no access to utility power, and the output can be used to power fans, TV, radio, phone charger, PC/laptop, lighting, induction stove, air conditioner, electromechanical tool, communication equipment, power distribution cabinet, outdoor camping equipment, marine AC power, factory equipment, and etc.

Model Encoding

NTN - 5K - 2 24 □

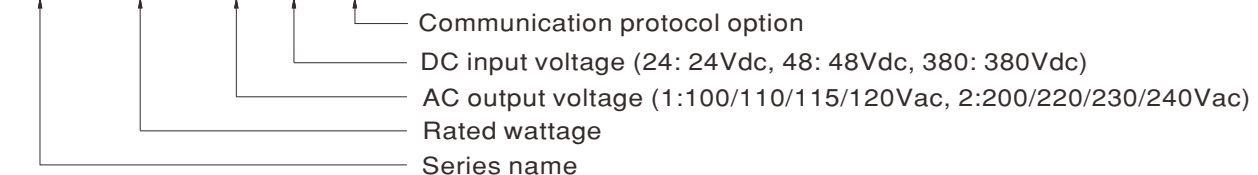

Type	Communication Protocol	Note
Blank	MODBus protocol	In Stock
CAN	CANBus protocol	In Stock



SPECIFICATION



MODEL NO.		NTN-5K-224 <input type="checkbox"/>	NTN-5K-248 <input type="checkbox"/>	NTN-5K-2380 <input type="checkbox"/>		
		<input type="checkbox"/> =Blank, CAN				
AC OUTPUT	RATED POWER(Continuous)	5000W				
	OVER RATED POWER(3 Min.)	5750W				
	PEAK POWER(10 Sec.)	7000W	7500W			
	SURGE POWER(30 Cycles)	8000W	10000W			
	AC VOLTAGE	Default setting set at 230VAC 200 / 220 / 230 / 240Vac selectable by DIP S.W				
	FREQUENCY	Default setting set at 50±0.1Hz 50/60Hz selectable by DIP S.W				
WAVEFORM	Note.1	True sine wave (THD<3%)				
AC REGULATION	±3.0% at rated input voltage					
DC INPUT	DC VOLTAGE	24Vdc	48Vdc	380Vdc		
	VOLTAGE RANGE (Typ.)	19 ~ 33Vdc	38 ~ 66Vdc	280 ~ 430Vdc		
	DC CURRENT (Typ.)	240A	120A	16A		
	NO LOAD DISSIPATION (Typ.)	NON-SAVING MODE	2.5A	1.4A	0.2A	
		SAVING MODE	Default disable, auto detect AC output load ≤ 10W will be changed to saving mode <25W			
	OFF MODE CURRENT DRAW	≤2mA				
	EFFICIENCY (Typ.)	Note.1	91%	93%	94.5%	
BATTERY TYPES	Lead Acid or li-ion					
PROTECTION	DC INPUT	LOW	ALARM	22±0.5Vdc	44±1Vdc	300±5Vdc
			SHUTDOWN	19±0.5Vdc	38±1Vdc	280±5Vdc
			RESTART	25±0.5Vdc	50±1Vdc	335±5Vdc
		HIGH	ALARM	31±0.5Vdc	62±1Vdc	420±5Vdc
			SHUTDOWN	33±0.5Vdc	66±1Vdc	430±5Vdc
			RESTART	30±0.5Vdc	60±1Vdc	400±5Vdc
	REVERSE POLARITY	No damage, re-power on to recover after fault condition is removed			By internal fuse open	
	AC OUTPUT	OVER TEMPERATURE	Shut down o/p voltage, recovers automatically after temperature goes down			
		OUTPUT SHORT	Shut down o/p voltage, re-power on to recover			
		OVER LOAD (Typ.)	105 ~ 115% load for 180 sec., 115% ~ 140% load for 10 sec., 105 ~ 115% load for 180 sec., 115% ~ 150% load for 10 sec. Protection type : Shut down o/p voltage, re-power on to recover			
CIRCUIT BREAKER		35A				
FUNCTION	REMOTE CONTROL	Power ON-OFF remote control by front panel dry contact connector(by RELAY), Open : Remote off ; Short : Normal work				
	COMMUNICATION	MODBus-RTU (RS-485) / CANBus				
AC UPS MODE	AC INPUT RANGE	200/220/230/240Vac ± 16%, recover ± 13%				
	FREQUENCY RANGE	45 ~ 65Hz				
	TRASFER TIME(Typ.)	10ms inverter → AC by pass				
AC CHARGER	BOOST CHARGE VOLTAGE	Default 28.8Vdc	Default 57.6Vdc	Default 400Vdc		
	FLOAT CHARGE VOLTAGE	Default 27.6Vdc	Default 55.2Vdc	Default 385Vdc		
	CHARGE VOLTAGE RANGE	20 ~ 30Vdc	40 ~ 60Vdc	290 ~ 400Vdc		
	CONSTANT CURRENT	135A	70A	11.3A		
	MAX. CHARGE POWER	4050W	4200W	4520W		
	TEMPERATURE COMPENSATION	By external NTC				
	POWER FACTOR (Typ.)	PF>0.98/230VAC at full load				
	EFFICIENCY (Typ.)	91%	93%	94%		
	AC CURRENT (Typ.)	25A/230VAC				
	INRUSH CURRENT (Typ.)	50A/230VAC				
	LEAKAGE CURRENT(Peak)	4.7mA/264VAC				
ENVIRONMENT	WORKING TEMP.	-30 ~ +70°C (Refer to "Derating curve")				
	WORKING HUMIDITY	20% ~ 90% RH non-condensing				
	STORAGE TEMP., HUMIDITY	-30 ~ +70°C / -22 ~ +158°F, 10 ~ 95% RH non-condensing				
	VIBRATION	10 ~ 500Hz, 3G 10min./1cycle, 60min. each along X, Y, Z axes				
SAFETY STANDARDS	SAFETY STANDARDS	CB IEC62368-1, UL62368-1, CSA C22.2 No. 62368-1, TUV BS EN/EN62368-1, AS/NZS 62368.1, EAC TP TC 004 approved				
	WITHSTAND VOLTAGE (Note.5)	DC I/P - AC:3.0KVAC AC - FG:1.5KVAC				
	ISOLATION RESISTANCE (Note.5)	DC I/P - AC O/P, DC I/P - FG, AC O/P - FG: 100M ohms / 500VDC / 25°C / 70% RH				
SAFETY & EMC (Note.4)	EMC EMISSION	Parameter	Standard		Test Level / Note	
		Radiated	BS EN/EN55032(CISPR32), FCC		Class A	
		Conducted	BS EN/EN55032(CISPR32), FCC		Class A	
		Harmonic Current	BS EN/EN61000-3-2		Class A	
		Voltage Flicker	BS EN/EN61000-3-3		-----	
	EMC IMMUNITY	BS EN/EN55035, EN61000-6-2				
		Parameter	Standard		Test Level / Note	
		ESD	BS EN/EN61000-4-2		Level 3, 8KV air ; Level 2, 4KV contact	
		Radiated	BS EN/EN61000-4-3		Level 3	
		EFT / Burst	BS EN/EN61000-4-4		Level 3	
		Surge	BS EN/EN61000-4-5		Level 4, 2KV/Line-Line 4KV/Line-Earth	
		Conducted	BS EN/EN61000-4-6		Level 3	
		Magnetic Field	BS EN/EN61000-4-8		Level 4	
		Voltage Dips and Interruptions	BS EN/EN61000-4-11		>95% dip 0.5 periods, 30% dip 25 periods, >95% interruptions 250 periods	
OTHERS	MTBF	200.9K hrs min. Telcordia TR/SR-332 (Bellcore) ; 17.8K hrs min. MIL-HDBK-217F (25°C)				
	DIMENSION	460*211*83.5mm (L*W*H)				
	PACKING	10.5Kg; 1pcs/ 10.5Kg/ 1.25CUFT				
NOTE	<p>1.Efficiency, AC regulation and THD are tested by 75% load, linear load at 25Vdc/50Vdc/400Vdc input voltage.</p> <p>2.All parameters not specified above are measured at 25Vdc/50Vdc/400Vdc input and 25°C of ambient temperature and set to factory setting.</p> <p>3.The tolerance of each voltage value by models is: 224→±0.5V; 248→±1V; 2380→±5V.</p> <p>4.The power supply is considered as an independent unit, but the final equipment still need to re-confirm that the whole system complies with the EMC directives. For guidance on how to perform these EMC tests, please refer to "EMI testing of component power supplies." (as available on https://www.meanwell.com/Upload/PDF/EMI_statement_en.pdf)</p> <p>5.During withstand voltage and isolation resistance testing, the screw "A" shall be temporarily removed, and shall be installed back after the testing.</p> <p>※ Product Liability Disclaimer : For detailed information, please refer to https://www.meanwell.com/serviceDisclaimer.aspx</p>					



5KW True Sine Wave Inverter with AC Charger / UPS

NTN-5K series



SPECIFICATION

MODEL NO.		NTN-5K-124 <input type="checkbox"/>		NTN-5K-148 <input type="checkbox"/>		
		<input type="checkbox"/> =Blank, CAN				
AC OUTPUT	RATED POWER(Continuous)	4000W				
	OVER RATED POWER(3 Min.)	4600W				
	PEAK POWER(10 Sec.)	5600W	6000W			
	SURGE POWER(30 Cycles)	7000W	8000W			
	AC VOLTAGE	Default setting set at 110VAC 100 / 110 / 115 / 120Vac selectable by DIP S.W				
	FREQUENCY	Default setting set at 60 ±0.1Hz 50/60Hz selectable by DIP S.W				
	WAVEFORM	Note.1	True sine wave (THD<3%)			
AC REGULATION		±3.0% at rated input voltage				
DC INPUT	DC VOLTAGE	24Vdc	48Vdc			
	VOLTAGE RANGE (Typ.)	19 ~ 33Vdc	38 ~ 66Vdc			
	DC CURRENT (Typ.)	200A	100A			
	NO LOAD DISSIPATION (Typ.)	NON-SAVING MODE	2.5A	1.4A		
		SAVING MODE	Default disable, auto detect AC output load ≤ 10W will be changed to saving mode <25W			
	OFF MODE CURRENT DRAW	≤2mA				
	EFFICIENCY (Typ.)	Note.1	89%	91%		
BATTERY TYPES		Lead Acid or li-ion				
PROTECTION	DC INPUT	LOW	ALARM	22 ±0.5Vdc	44 ±1Vdc	
			SHUTDOWN	19 ±0.5Vdc	38 ±1Vdc	
			RESTART	25 ±0.5Vdc	50 ±1Vdc	
		HIGH	ALARM	31 ±0.5Vdc	62 ±1Vdc	
			SHUTDOWN	33 ±0.5Vdc	66 ±1Vdc	
			RESTART	30 ±0.5Vdc	60 ±1Vdc	
	REVERSE POLARITY		No damage, re-power on to recover after fault condition is removed			
	AC OUTPUT	OVER TEMPERATURE		Shut down o/p voltage, recovers automatically after temperature goes down		
		OUTPUT SHORT		Shut down o/p voltage, re-power on to recover		
		OVER LOAD (Typ.)		105 ~ 115% load for 180 sec., 115% ~ 150% load for 10 sec.		
CIRCUIT BREAKER		Protection type : Shut down o/p voltage, re-power on to recover 50A				
FUNCTION	REMOTE CONTROL		Power ON-OFF remote control by front panel dry contact connector(by RELAY), Open : Remote off ; Short : Normal work			
	COMMUNICATION		MODBus-RTU (RS-485) / CANBus			
AC UPS MODE	AC INPUT RANGE		100/110/115/120Vac ±16%, recover ±13%			
	FREQUENCY RANGE		45 ~ 65Hz			
	TRASFER TIME(Typ.)		10ms inverter → AC by pass			
AC CHARGER	BOOST CHARGE VOLTAGE		Default 28.8Vdc	Default 57.6Vdc		
	FLOAT CHARGE VOLTAGE		Default 27.6Vdc	Default 55.2Vdc		
	CHARGE VOLTAGE RANGE		20 ~ 30Vdc	40 ~ 60Vdc		
	CONSTANT CURRENT		120A	60A		
	MAX. CHARGE POWER		3600W	3600W		
	TEMPERATURE COMPENSATION		By external NTC			
	POWER FACTOR (Typ.)		PF>0.98/115VAC at full load			
	EFFICIENCY (Typ.)		89%	91%		
	AC CURRENT (Typ.)		20A/110VAC			
	INRUSH CURRENT (Typ.)		25A/110VAC			
LEAKAGE CURRENT(Peak)		4.7mA/264VAC				
ENVIRONMENT	WORKING TEMP.		-30 ~ +70°C (Refer to "Derating curve")			
	WORKING HUMIDITY		20% ~ 90% RH non-condensing			
	STORAGE TEMP., HUMIDITY		-30 ~ +70°C / -22 ~ +158°F, 10 ~ 95% RH non-condensing			
	VIBRATION		10 ~ 500Hz, 3G 10min./1cycle, 60min. each along X, Y, Z axes			
SAFETY & EMC (Note.4)	SAFETY STANDARDS		CB IEC62368-1, UL62368-1, CSA C22.2 No. 62368-1, TUV BS EN/EN62368-1, EAC TP TC 004 approved			
	WITHSTAND VOLTAGE		DC I/P - AC:3.0KVAC AC - FG:1.5KVAC			
	ISOLATION RESISTANCE		DC I/P - AC O/P, DC I/P - FG, AC O/P - FG: 100M ohms / 500VDC / 25°C / 70% RH			
	EMC EMISSION	Parameter	Standard	Test Level / Note		
		Radiated	FCC	Class A		
	Conducted	FCC	Class A			
OTHERS	MTBF		200.9K hrs min. Telcordia TR/SR-332 (Bellcore) ; 17.8K hrs min. MIL-HDBK-217F (25°C)			
	DIMENSION		460*211*83.5mm (L*W*H)			
	PACKING		10.5Kg; 1pcs/ 10.5Kg/ 1.25CUFT			
NOTE	<p>1.Efficiency, AC regulation and THD are tested by 75% load, linear load at 25Vdc/50Vdc input voltage.</p> <p>2.All parameters not specified above are measured at 25Vdc/50Vdc input and 25°C of ambient temperature and set to factory setting.</p> <p>3.The tolerance of each voltage value by models is: 124→±0.5V; 148→±1V.</p> <p>4.The power supply is considered as an independent unit, but the final equipment still need to re-confirm that the whole system complies with the EMC directives. For guidance on how to perform these EMC tests, please refer to "EMI testing of component power supplies." (as available on https://www.meanwell.com/Upload/PDF/EMI_statement_en.pdf)</p> <p>※ Product Liability Disclaimer : For detailed information, please refer to https://www.meanwell.com/serviceDisclaimer.aspx</p>					



5KW True Sine Wave Inverter with AC Charger / UPS

NTN-5K series

DERATING CURVE

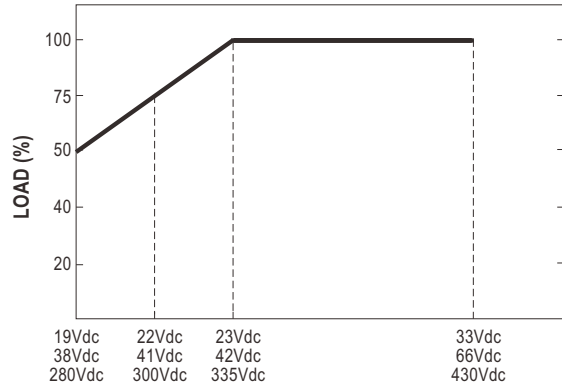
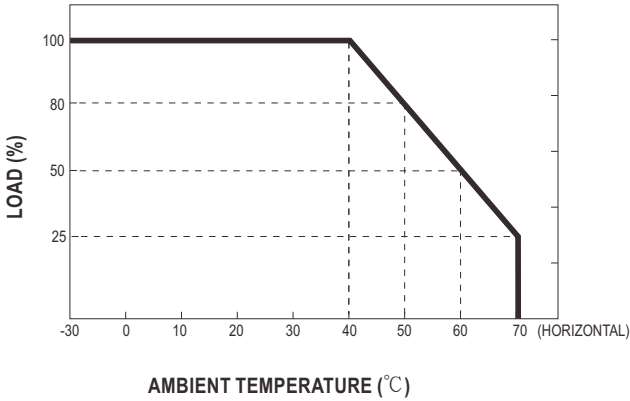

CHARGING CURVE

☉ Default 3 stage charging curve

3 Stage

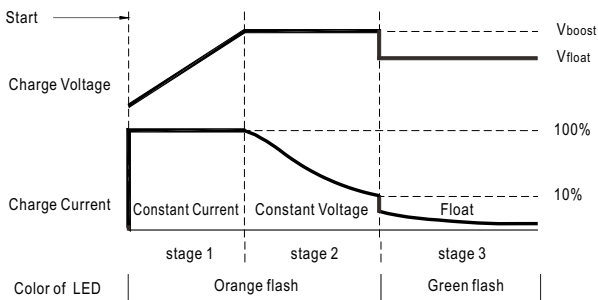

☉ Embedded 3 stage charging curves

MODEL	V _{boost}	V _{float}	C.C.	Adjustable by MODBus / CANBus
124	Default 28.8Vdc	27.6Vdc	120A max.	20~30Vdc
224			135A max.	
148	Default 57.6Vdc	55.2Vdc	60A max.	40~60Vdc
248			70A max.	
380Vdc	Default 400Vdc	385Vdc	11.3A max.	290~400Vdc

☉ Suitable for lead-acid batteries (flooded, Gel and AGM) or li-ion

BLOCK DIAGRAM

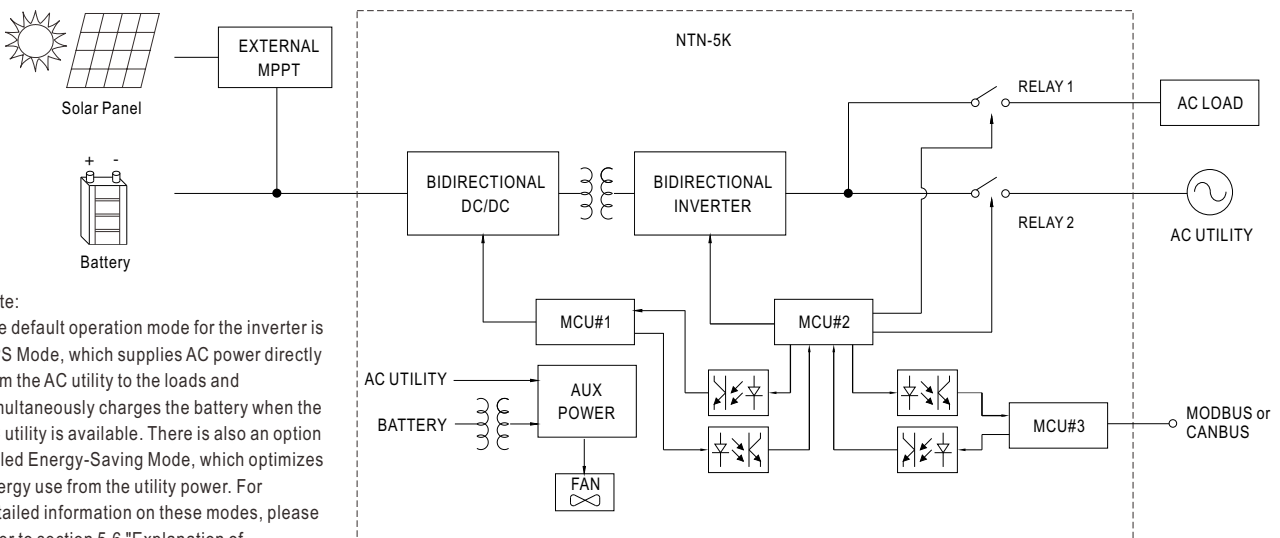

Note:
The default operation mode for the inverter is UPS Mode, which supplies AC power directly from the AC utility to the loads and simultaneously charges the battery when the AC utility is available. There is also an option called Energy-Saving Mode, which optimizes energy use from the utility power. For detailed information on these modes, please refer to section 5.6 "Explanation of Operating Logic" in the manual.



■ Function Manual

1.Support MODBus / CANBus Communication

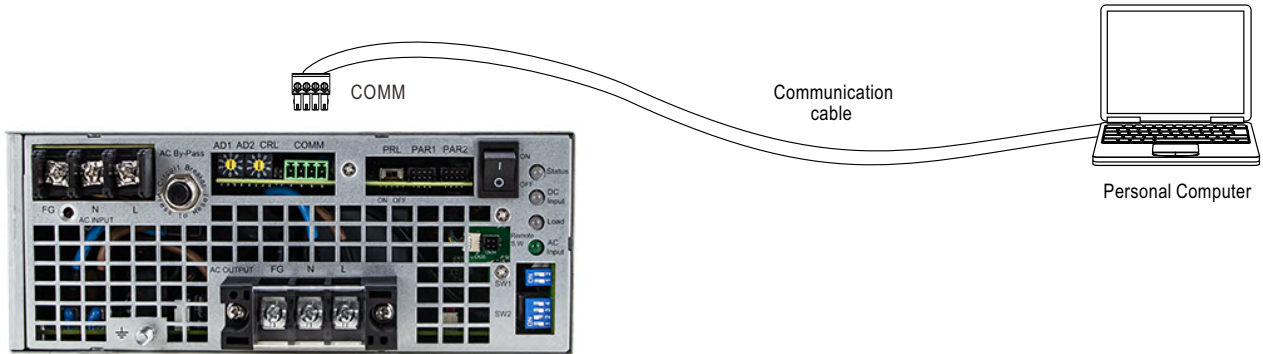

※ Please refer to the user manual for detailed instructions.

2. Remote ON-OFF Control

PAR1/PAR2	Remote ON-OFF	AC Output Status
Pin1:3	Short	Power inverter ON
Pin1:3	Open	Power inverter OFF

3.AC Output Voltage、 Frequency、 Power saving mode selectable by DIP SW



AC Output Voltage、 Frequency、 Power saving mode selectable by DIP SW

S1	S2	S3	S4
OFF	OFF : 100Vac or 200Vac	ON : 50Hz	ON : Saving mode
OFF	ON : 110Vac or 220Vac		
ON	OFF : 115Vac or 230Vac	OFF: 60Hz	OFF: Non-Saving mode
ON	ON : 120Vac or 240Vac		

4.3Ø 4W and 1Ø 3W AC output Voltage connection selectable by DIP SW



©3Ø 4-wire / Y

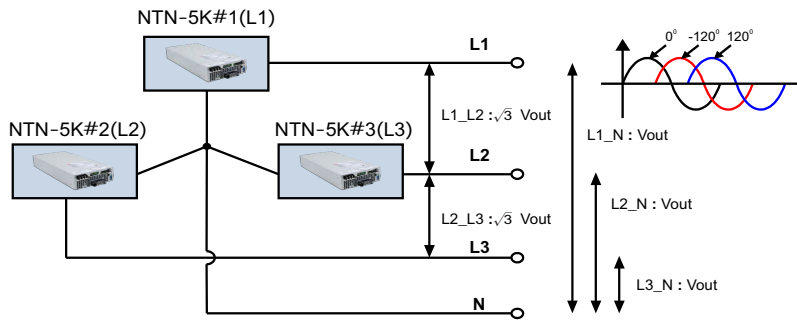

Fig 4.1

S1	S2	AC output phase
OFF	OFF	L1, 0°
OFF	ON	L2, -120°
ON	OFF	L3, +120°

Note: Please refer to 5.3 Three-phase 4-wire output on page 23 of the user manual for detailed instructions.

©1Ø 3-wire(Split phase system only supports 124 and 148)

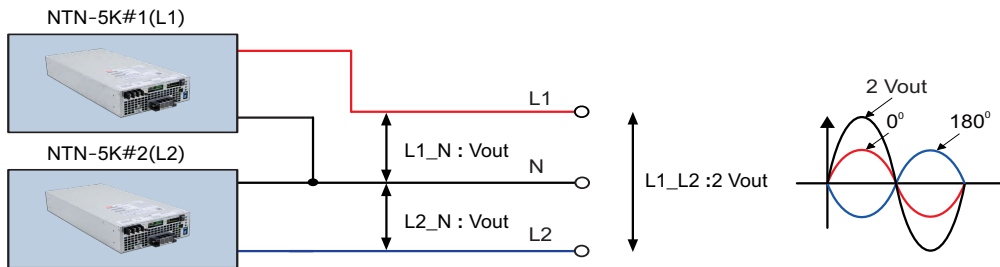

Fig 4.2

S1	S2	AC output phase
OFF	OFF	L1, 0°
ON	ON	L2, +180°

Note: Please refer to 5.4 Single-phase 3-wire Output on page 27 of the user manual for detailed instructions.

5. Temperature compensation(3 stage only)

Temperature compensation function to prolong battery life for lead-acid batteries. Temperature compensation range is 0 ~ 40°C.

The battery temperature sensor comes along with the charger can be connected to the unit to allow temperature compensation of the charging voltage. If the sensor is not used, the charger works normally.





6.AC Output Parallel Function

NTN-5K has the built-in active current sharing function and can be connected in parallel, up to 6 units, to provide higher AC output power as exhibited below :

- ※ The inverter should be paralleled using short and large diameter wiring and then connected to the load.
- ※ The total output current must not exceed the value determined by the following equation:

Maximum output current at parallel operation = (Rated current per unit) x (Number of unit) x 95% ; when parallel unit less than 6.

- ※ PAR1/PAR2, PRL Function pin connection

Parallel	PSU1		PSU2		PSU3		PSU4		PSU5		PSU6	
	PAR1	PRL	PAR1	PRL	PAR1	PRL	PAR1	PRL	PAR1	PRL	PAR1	PRL
1 unit	X	ON	—	—	—	—	—	—	—	—	—	—
2 unit	V	ON	V	ON	—	—	—	—	—	—	—	—
3 unit	V	ON	V	OFF	V	ON	—	—	—	—	—	—
4 unit	V	ON	V	OFF	V	OFF	V	ON	—	—	—	—
5 unit	V	ON	V	OFF	V	OFF	V	OFF	V	ON	—	—
6 unit	V	ON	V	OFF	V	OFF	V	OFF	V	OFF	V	ON

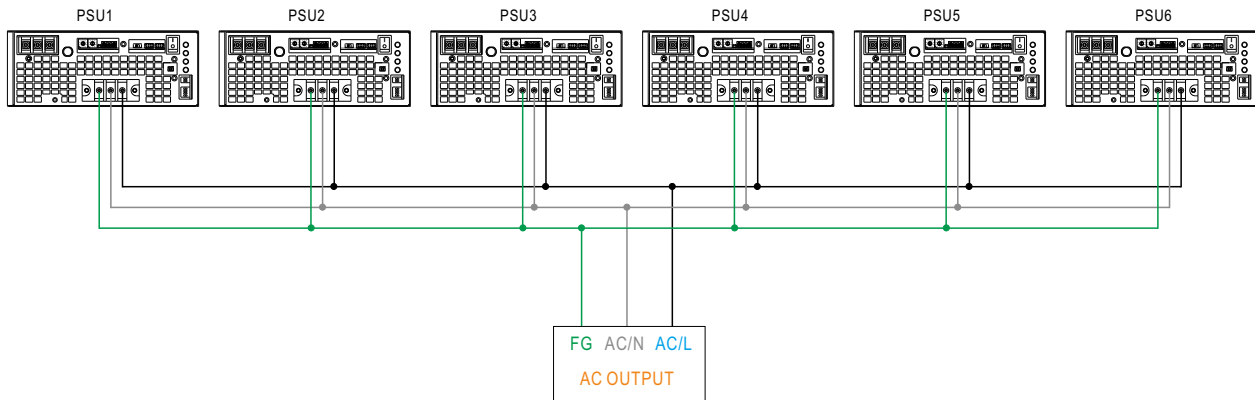
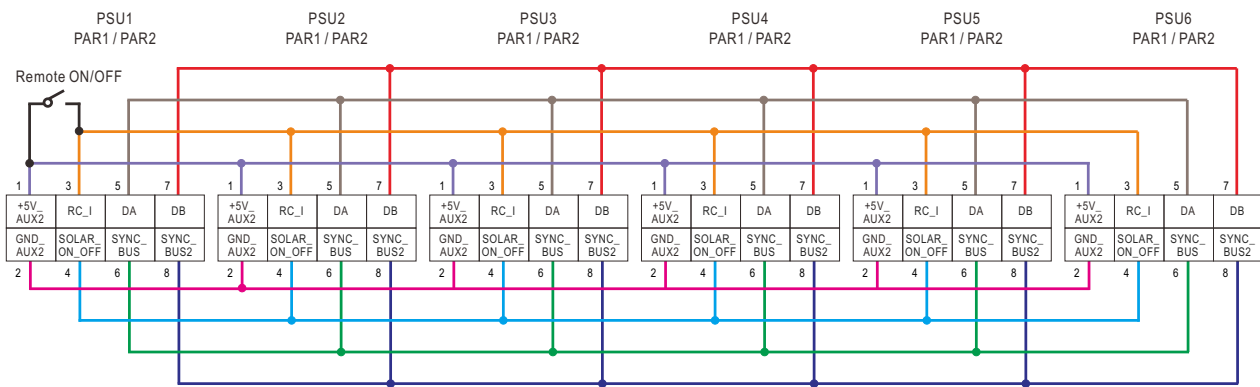







Fig 6.1



















↑
If the lines of PAR1 / PAR2 are too long, they should be twisted in pairs to avoid the noise.



LED STATUS

Normal work:













Status	Green	Orange	Red
	 Inverter OK  System check	 Remote off  Saving mode	 Abnormal Status (See below table)



DC Input	Green	Orange	Red
	 25~31Vdc  50~62Vdc  335~420Vdc  Maintain	 22~25Vdc  44~50Vdc  300~335Vdc  Charging	 <22Vdc or >31Vdc  <44Vdc or >62Vdc  <300Vdc or >420Vdc

Load	Green	Orange	Red
Inverter Mode	 <40% load	 40~80% load	 >80% load
Bypass Mode	 <40% load	 40~80% load	 >80% load

AC Input	Green	Orange	Red
	 Utility OK  Utility error  Utility disconnected	-----	-----

Abnormal status :

LED Indicator	Abnormal Indication
Status  DC Input  Load 	Output overload or AC output short circuit
Status  DC Input  Load 	Abnormal DC voltage
Status  DC Input  Load 	Over temperature or Fan lock
Status  DC Input  Load 	Inverter fail

-  Light
-  Light off
-  Flash

Case No.223

MECHANICAL SPECIFICATION

(Unit: mm , tolerance ±0.5mm)

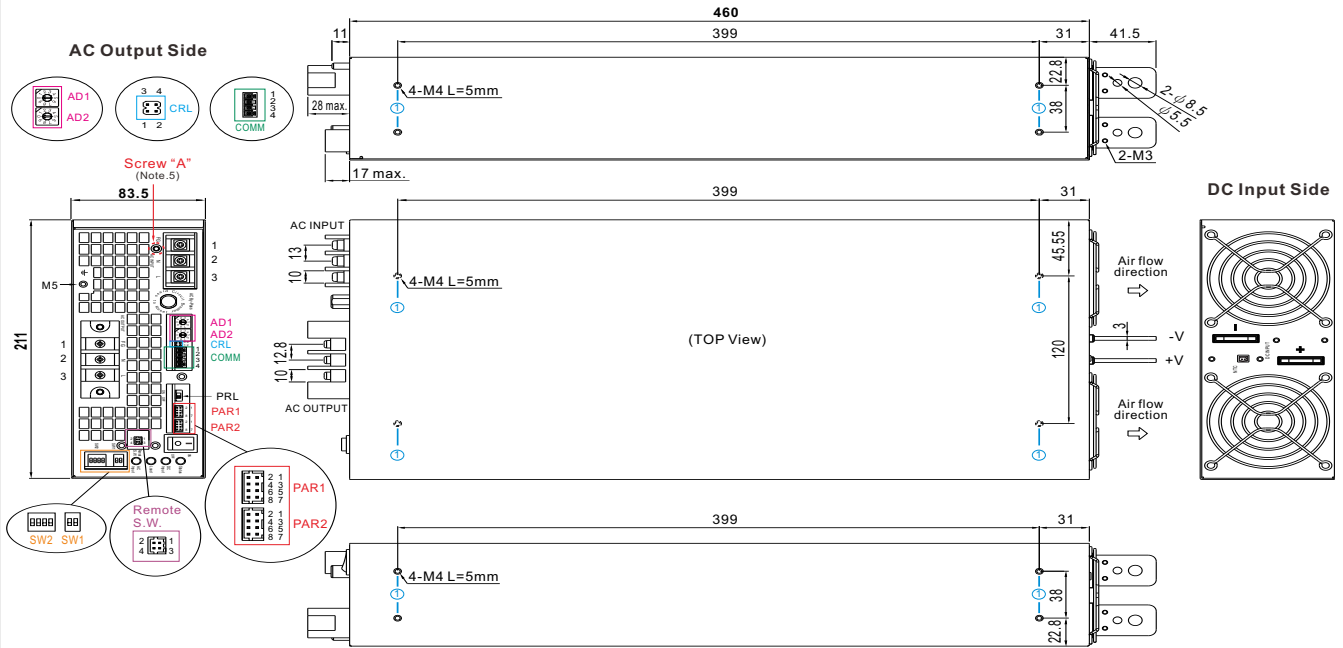

※ Mounting Instruction

Hole No.	Recommended Screw Size	MAX. Penetration Depth L	Recommended mounting torque
①	M4	5mm	7~10Kgf-cm

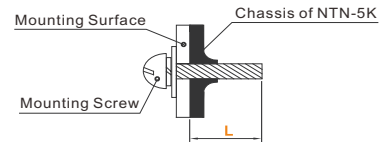

※ Terminal Pin No. Assignment

Pin No.	Assignment	AC input	AC output	Maximum mounting torque
1	FG	1 2 3	1 2 3	18Kgf-cm
2	AC/N			
3	AC/L			

※ AC IN Connector Pin No. Assignment (COMM):

Pin No.	Function	Description
1	GND-AUX	Auxiliary voltage output GND.
2	D+/CANH	For MODBus model: Data line used in MODBus interface.(Note)
		For CANBus model: Data line used in CANBus interface.(Note)
3	D-/CANL	For MODBus model: Data line used in MODBus interface.(Note)
		For CANBus model: Data line used in CANBus interface.(Note)
4	+5V_AUX	Auxiliary voltage output, 4.5~5.5V, referenced to GND_AUX1

Note: Isolated signal, referenced to GND_AUX2

※ Control Pin No. Assignment (CRL):

Pin No.	Function	Description
1,3	RL	Short: Termination resistors(120Ω) For MODBus/CANBus communication, please use Jumper (pin1,3)
2,4	NC	No need to communicate, please use Jumper (pin2,4)

※ AD1,AD2 switch for MODBus/CANBus interface address setting, please refer to the user manual for more details

※ Control Pin No. Assignment (Remote S.W.): HRS DF11-04DP-2DS or equivalent

Mating Housing	HRS DF11-04DS or equivalent
Terminal	HRS DF11-04SC or equivalent

Pin No.	Function	Description
1,2,3,4	REMOTE SWITCH	The unit can be remotely turned the output ON/OFF by dry contact between Pin1,2 & 3,4. Power ON : Short Pin1 to 2 and Pin3 to 4 ; Power OFF : Pin1 ~ Pin4 open.

※ Control Pin No. Assignment (PAR1,PAR2) : HRS DF11-08DP-2DS or equivalent

Mating Housing	HRS DF11-08DS or equivalent
Terminal	HRS DF11-08SC or equivalent

Pin No.	Function	Description
1	+5V_AUX2	Auxiliary voltage output, 4.5~5.5V, referenced to GND_AUX2 (pin2). (Only for REMOTE ON-OFF)
2	GND_AUX2	Auxiliary voltage output GND_AUX2 (pin2).
3	REMOTE ON-OFF	The unit can turn the output ON/OFF by dry contact between Remote ON/OFF and +5V_AUX2.(Note) Short : Power ON ; Open : Power OFF
4	SOLAR_ON_OFF	External MPPT charger control, referenced to GND_AUX2 (pin2).
5	DA	Data line used for parallel control.
6	SYNC_BUS	Phase synchronization used for parallel control.
7	DB	Data line used for parallel control.
8	SYNC_BUS2	Mode synchronization used for parallel control.

Note: Isolated signal, referenced to GND_AUX2

■ Accessory List

※ NTC Sensor and Remote Control mating along with NTN-5K (Standard accessory)

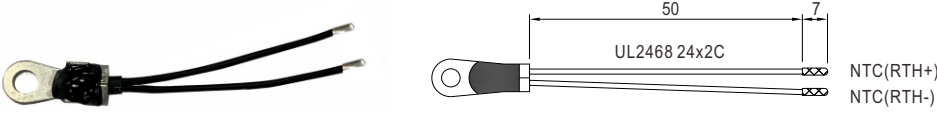
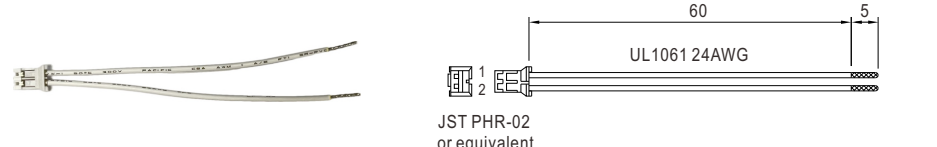
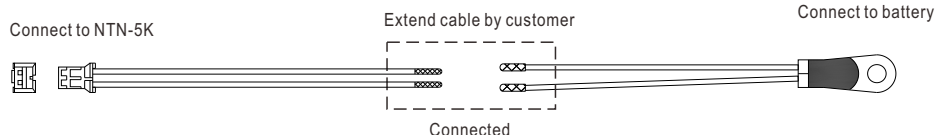

	Item	Quantity
①	<p>NTC sensor wire</p> 	1
②	<p>NTC mating wire</p> 	1
<p>Connection Diagram</p> 		

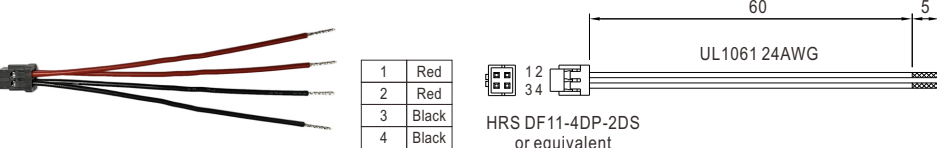
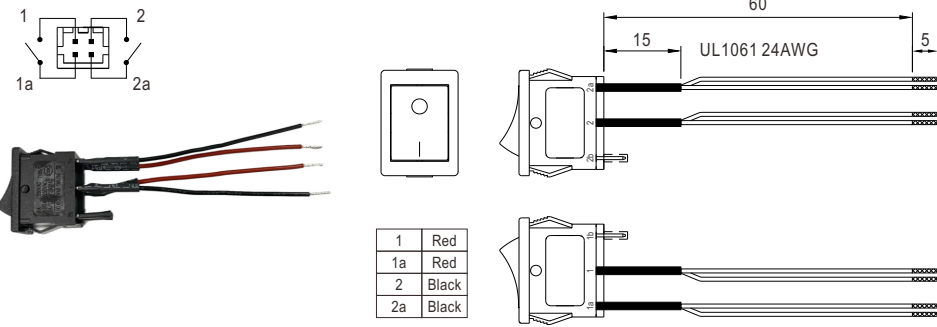
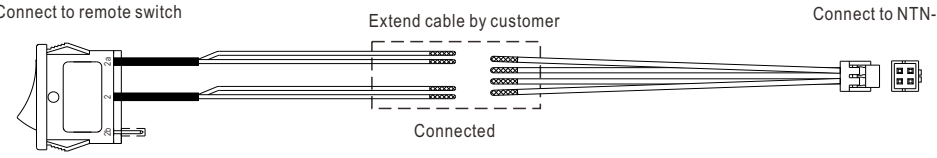
※ Remote Control mating along with NTN-5K (Standard accessory)

	Item	Quantity
①	<p>Remote S.W mating wire</p> 	1
②	<p>Remote S.W mating wire</p> 	1
<p>Connection Diagram</p> 		

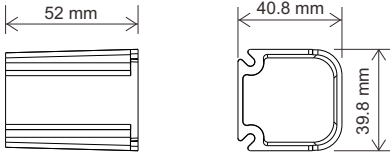

※ Terminal protector mating along with NTN-5K (Standard accessory)

	Item	Quantity
①	 	1
②		1
③		4

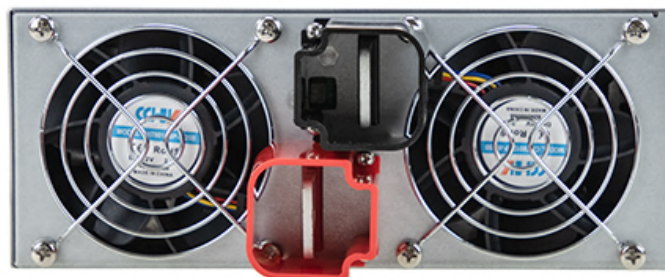
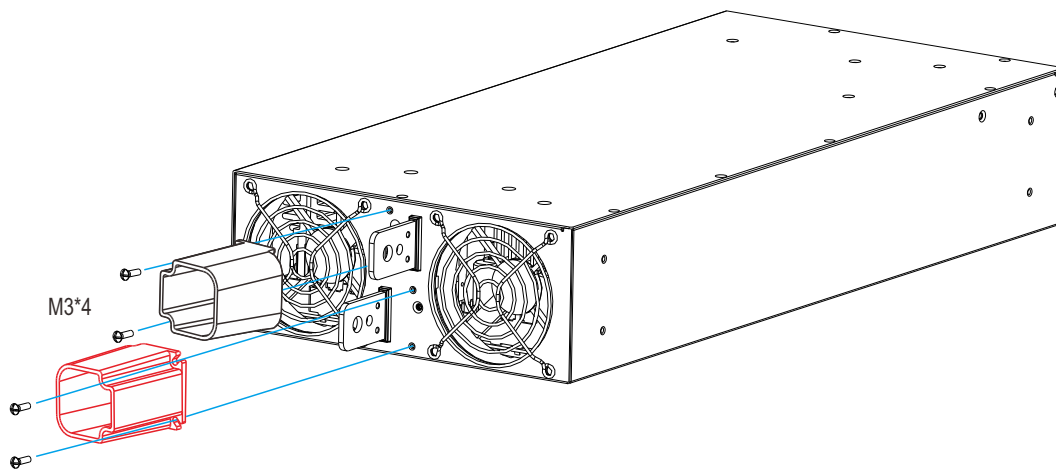



■ TYPICAL APPLICATION



- 1 Battery Bank
- 2 Off-Grid DC/AC Inverter (NTN series)
- 3 AC Outlet



- 1 Utility Input (Shore)
- 2 Battery Bank
- 3 Off-Grid DC/AC Inverter (NTN series)
- 4 AC Outlet

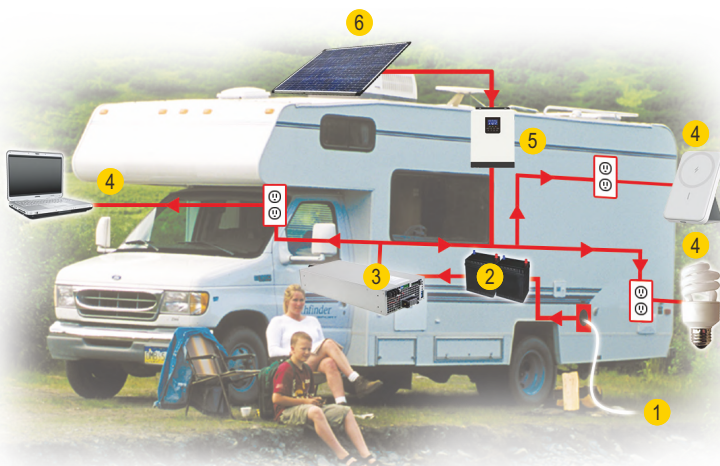

- 1 Utility Inlet
- 2 Battery Bank
- 3 Off-Grid DC/AC Inverter (NTN series)
- 4 AC Outlet
- 5 MPPT Charger (External)
- 6 Solar Panel (External)



■ SYSTEM CONFIGURATION

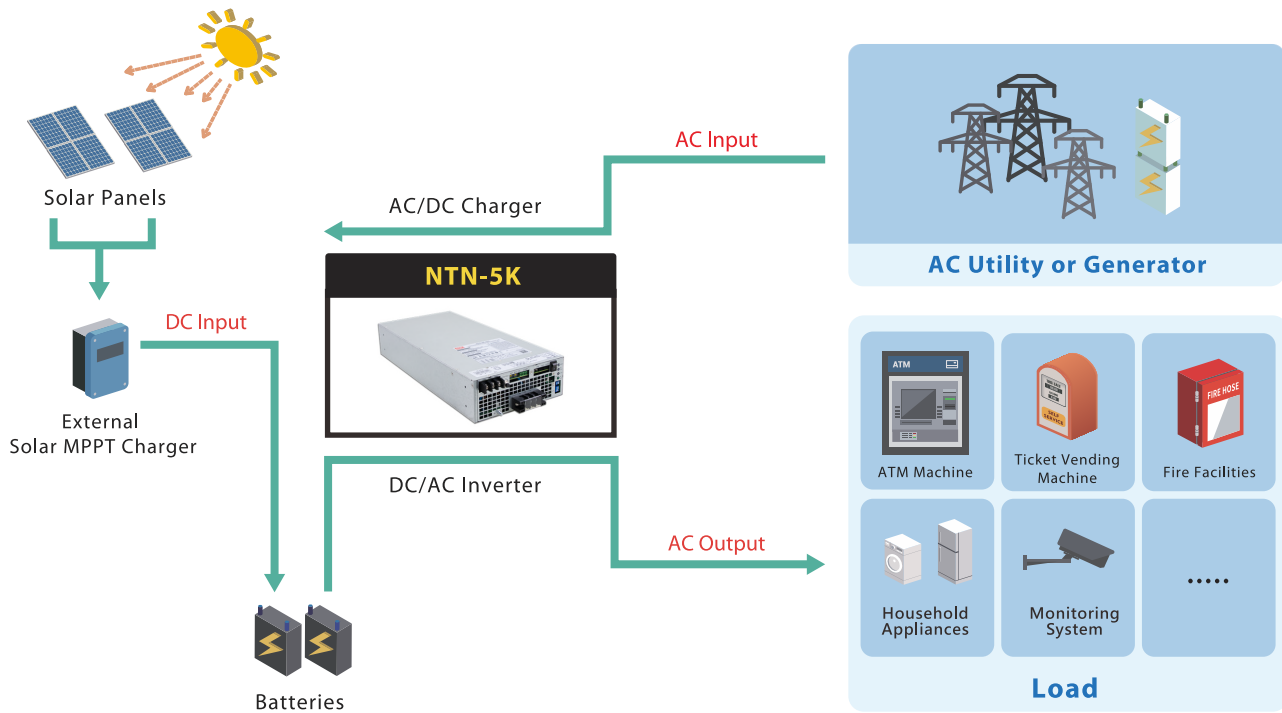

- 1 Battery Bank
- 2 Off-Grid DC/AC Solar Inverter (NTN series)
- 3 AC Outlet