



30KW 3 $\phi$  3W High Efficiency Digital Power Supply

# SHP-30K-HV series

## Dimension

L	*	W	*	H
540	*	424	*	83.5(2U) mm
21.3	*	16.7	*	3.29(2U) inch

User's Manual



Video



Front



Back



## Features

- 3 $\phi$  3-wire without Neutral / 340~530VAC wide input range
- High efficiency up to 97%
- 2U high 19"-inch rack with forced air cooling
- Built-in CANBus/Optional PMBus/MODBus-RTU/RS-485 protocol
- Output voltage and constant current level programmable
- Active current sharing up to 12 units(285KW) and more
- Built-in remote ON-OFF control / Auxiliary power / Alarm signa / Fan fail
- Protections: Short circuit / Overload / Over voltage / Over temperature
- Double insulation for 55V model
- 5 years warranty

## Applications

- Energy & power system for automation
- U.V or laser diode application
- Electrolysis system
- Laser processing machine
- Burn-in facility
- RF application
- EV charging station

## GTIN CODE

MW Search: <https://www.meanwell.com/serviceGTIN.aspx>

## Description

SHP-30K-HV series is a 30KW 3 $\phi$  3W input AC/DC power supply. This series operates for the wide range three phase AC input (3 phase 3 wire / 340~530VAC) neutral is not needed, and offers the models with DC outputs (55V/115V/230V/380V) that mostly demanded by various industries. Can be working at ambient temperature up to 70°C with forced air cooling. Moreover, SHP-30K-HV series provides vast design flexibility by equipping various built-in functions such as output programming, active current sharing, remote ON-OFF control, auxiliary power, and communication protocols, that will not only satisfy marker demand, but also enhance automation purpose.

## Model Encoding

SHP - 30K - 115

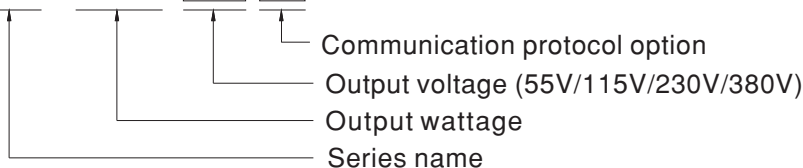

Type	Communication Protocol	Note
Blank	CANBus	In Stock
-PM	PMBus	By request
-MOD	MODBus-RTU/RS-485	By request



# 30KW 3 $\phi$ 3W High Efficiency Digital Power Supply **SHP-30K-HV** series

## SPECIFICATION

MODEL	SHP-30K-55	SHP-30K-115	SHP-30K-230	SHP-30K-380	
OUTPUT	DC VOLTAGE (factory default)	55V	115V	230V	380V
	CURRENT (factory default)	346A	261A	130.5A	79A
	CURRENT RANGE	0 ~ 346A	0 ~ 261A	0 ~ 139A	0 ~ 90A
	RATED POWER (max.)	19000W	30000W	30000W	30000W
	FULL POWER VOLTAGE RANGE	48 ~ 57.6V	115 ~ 138V	216 ~ 260V	334 ~ 400V
	RIPPLE & NOISE (max.) Note.2	0.55Vp-p	1Vp-p	1.5Vp-p	2Vp-p
	VOLTAGE ADJ. RANGE	39 ~ 57.6V	90 ~ 138V	170 ~ 260V	260 ~ 400V
		Can be adjusted via built-in potentiometer			
	VOLTAGE TOLERANCE Note.3	± 1.0%	± 1.0%	± 1.0%	± 1.0%
	LINE REGULATION	± 0.5%	± 0.5%	± 0.5%	± 0.5%
	LOAD REGULATION	± 0.5%	± 0.5%	± 0.5%	± 0.5%
SETUP, RISE TIME	300ms, 100ms at full load				
HOLD UP TIME (Typ.)	20ms / 400VAC at 75% load	16ms / 400VAC at full load			
INPUT	VOLTAGE RANGE Note.5	3 $\phi$ 3-wire / 340 ~ 530VAC			
	FREQUENCY RANGE	47 ~ 63Hz			
	POWER FACTOR (Typ.)	≥ 0.98/400VAC/480VAC at full load			
	EFFICIENCY (Typ.) Note.6	95%	96%	96.5%	97%
	AC CURRENT (Typ.)	30A/400VAC 25.2A/480VAC	47A/400VAC 39A/480VAC		
	INRUSH CURRENT (Typ.)	60A/400VAC 80A/480VAC			
LEAKAGE CURRENT	<14mA peak / 530VAC, <9mA rms / 530VAC				
PROTECTION	OVER LOAD	100 ~ 105% of rated current Protection type : Constant current limiting, unit will shutdown after 5 sec. re-power on to recover			
	OVER VOLTAGE	60.5 ~ 69.1V	145 ~ 166V	273 ~ 312V	420 ~ 480V
		Protection type : Shut down o/p voltage, re-power on to recover			
OVER TEMPERATURE	Shut down o/p voltage, recovers automatically after temperature goes down				
FUNCTION	CURRENT SHARING	Up to 12 units or more. Please refer to the Current share derating curve			
	OUTPUT VOLTAGE PROGRAMMABLE	Adjustment of output voltage is allowable between 50 ~ 120% of nominal output voltage. Please refer to the PV curve function manual			
	CONSTANT CURRENT LEVEL PROGRAMMABLE	Adjustment of constant current level is allowable between 1 ~ 100% of rated current. Please refer to the PC curve function manual			
	AUXILIARY POWER(AUX)	12V@1.5A tolerance ± 5%, ripple 150mVp-p			
	REMOTE ON-OFF CONTROL	Please refer to the function manual.			
	ALARM SIGNAL OUTPUT	AC-OK, DC-OK, Fan Fail, T-ALARM. Please refer to the function manual.			
	DC-OK/T-ALARM/FAN FAIL SIGNAL	The TTL signal output, PSU turn on = -0.5 ~ 0.5V ; PSU turn off = 3.5 ~ 5.5V. Please refer to the function manual			
AC-OK SIGNAL	The TTL signal output, PSU turn on = 3.5 ~ 5.5V ; PSU turn off = -0.5 ~ 0.5V. Please refer to the function manual				
ENVIRONMENT	WORKING TEMP.	-30 ~ +70°C (Refer to "Derating Curve")			
	WORKING HUMIDITY	20 ~ 90% RH non-condensing			
	STORAGE TEMP., HUMIDITY	-40 ~ +85°C, 10 ~ 95% RH non-condensing			
	TEMP. COEFFICIENT	± 0.03%/°C (0 ~ 50°C)			
	VIBRATION	10 ~ 500Hz, 2G 10min./1cycle, 60min. each along X, Y, Z axes			
SAFETY & EMC (Note 7)	SAFETY STANDARDS	UL62368-1, CAN/CSA C22.2 No. 62368-1, TUV BS EN/EN62368-1, EAC TP TC 004 approved			
	WITHSTAND VOLTAGE Note.4	I/P-O/P:4.25KVAC I/P-FG:3KVAC O/P-FG:1.25KVAC	I/P-O/P:4.25KVAC	I/P-FG:3KVAC	O/P-FG:3KVAC
	ISOLATION RESISTANCE Note.4	I/P-O/P, I/P-FG, O/P-FG:100M Ohms / 500VDC / 25°C / 70% RH			
	EMC EMISSION	Parameter	Standard		Test Level / Note
		Conducted	BS EN/EN55032 (CISPR32) / EN55011 (CISPR11)		Class A
		Radiated	BS EN/EN55032 (CISPR32) / EN55011 (CISPR11)		Class A
		Harmonic Current	BS EN/EN61000-3-12		-----
	Voltage Flicker	BS EN/EN61000-3-11		-----	
	EMC IMMUNITY	EN55024, EN61204-3, EN61000-6-2			
		Parameter	Standard		Test Level / Note
ESD		BS EN/EN61000-4-2		Level 3, 8KV air ; Level 2, 4KV contact	
Radiated		BS EN/EN61000-4-3		Level 3	
EFT / Burst		BS EN/EN61000-4-4		Level 3	
Surge		BS EN/EN61000-4-5		Level 4, 4KV/Line-Earth ; Level 3, 2KV/Line-Line	
Conducted		BS EN/EN61000-4-6		Level 3	
Magnetic Field	BS EN/EN61000-4-8		Level 4		
Voltage Dips and Interruptions	BS EN/EN61000-4-34		>95% dip 0.5 periods, 30% dip 25 periods, >95% interruptions 250 periods		
OTHERS	MTBF	188.1K hrs min. Telcordia SR-332 (Bellcore) ; 20.9K hrs min. MIL-HDBK-217F (25°C)			
	DIMENSION	540*424*83.5mm (L*W*H)			
	PACKING	23.4Kg; 1pcs/23.4Kg/2.82CUFT			
NOTE	<ol style="list-style-type: none"> <li>All parameters NOT specially mentioned are measured at 400VAC input, rated load and 25°C of ambient temperature.</li> <li>Ripple &amp; noise are measured at 20MHz of bandwidth by using a 12" twisted pair-wire terminated with a 0.1<math>\mu</math>f &amp; 47<math>\mu</math>f parallel capacitor.</li> <li>Tolerance :includes set up tolerance, line regulation and load regulation.</li> <li>During withstand voltage and isolation resistance testing, the screw "A" shall be temporarily removed, and shall be installed back after the testing.</li> <li>Derating may be needed under low input voltages. Please check the derating curve for more details.</li> <li>The efficiency is measured at 75% load and 480VAC input.</li> <li>The power supply is considered a component which will be installed into a final equipment. All the EMC tests are been executed by mounting the unit on a 600mm*900mm metal plate with 1mm of thickness. The final equipment must be re-confirmed that it still meets EMC directives. For guidance on how to perform these EMC tests, please refer to "EMI testing of component power supplies." (as available on <a href="https://www.meanwell.com/Upload/PDF/EMI_statement_en.pdf">https://www.meanwell.com/Upload/PDF/EMI_statement_en.pdf</a>)</li> <li>The ambient temperature derating of 3.5°C/1000m with fanless models and of 5°C/1000m with fan models for operating altitude higher than 2000m(6500ft).</li> <li>If use PV signal to adjust Vo, under certain operations conditions, ripple noise of Vo might slightly go over rating defined in this specification.</li> <li>Under light load condition, output voltage ripple will exceed specification. The behavior can be minimized by increasing the load.</li> </ol> <p>※ Product Liability Disclaimer : For detailed information, please refer to <a href="https://www.meanwell.com/serviceDisclaimer.aspx">https://www.meanwell.com/serviceDisclaimer.aspx</a></p>				



30KW 3 $\phi$  3W High Efficiency Digital Power Supply

# SHP-30K-HV series

## ■ BLOCK DIAGRAM

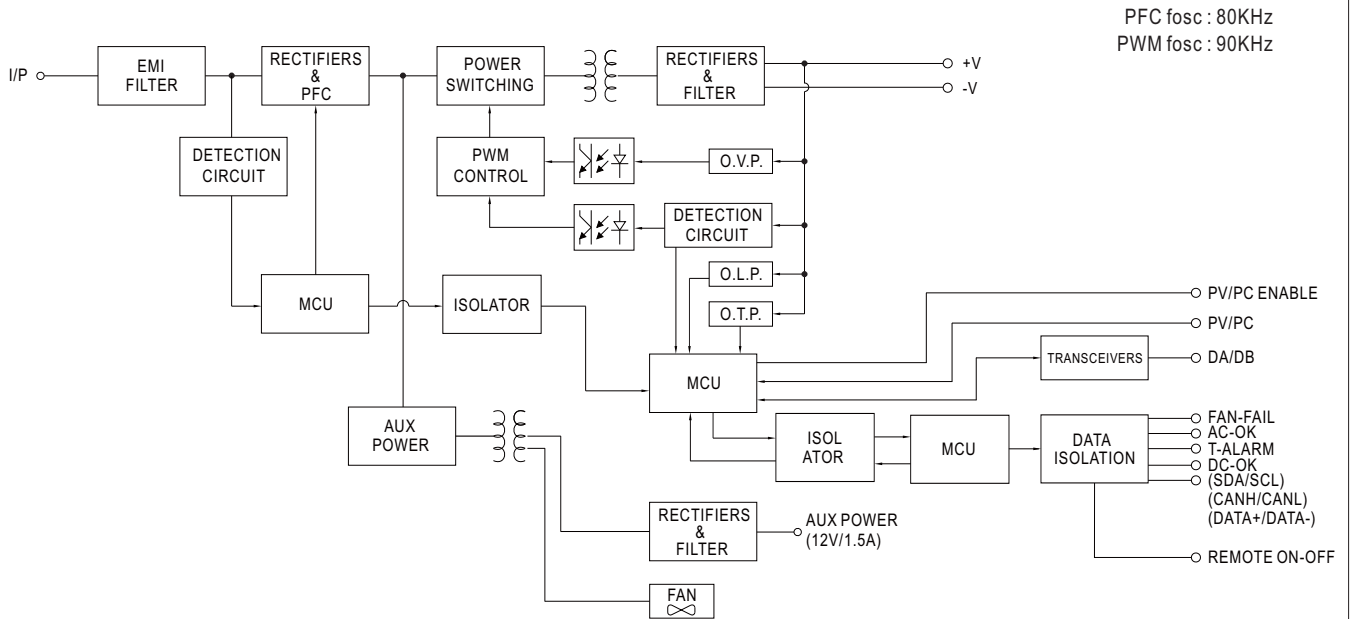

## ■ DERATING CURVE

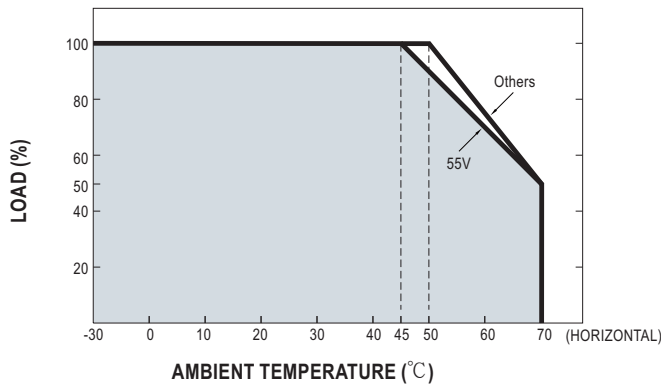



30KW 3 $\phi$  3W High Efficiency Digital Power Supply

**SHP-30K-HV** series

■ **STATIC CHARACTERISTICS**

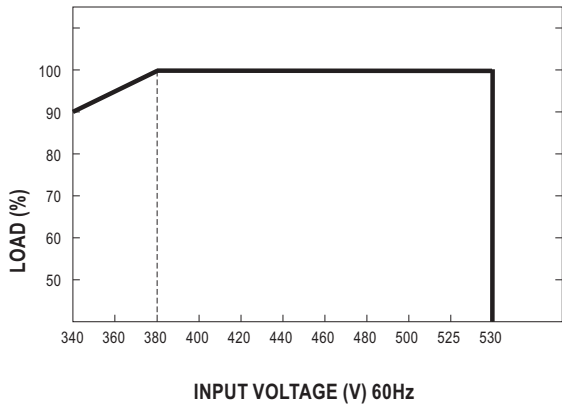

■ **EFFICIENCY VS LOAD (380V MODEL)**

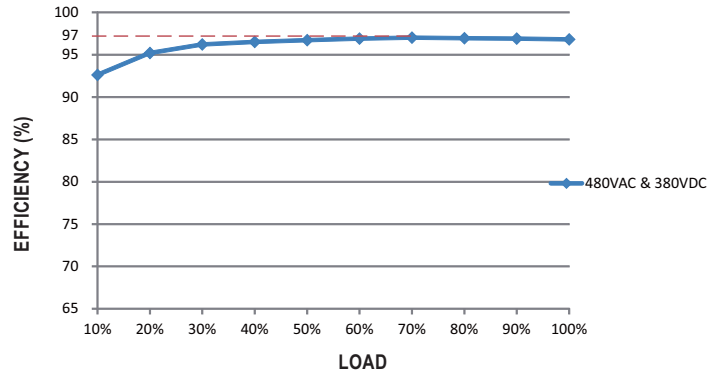

■ **AC Power Connection**

◎ 3 $\phi$  3-wire /  $\Delta$  340VAC~530VAC

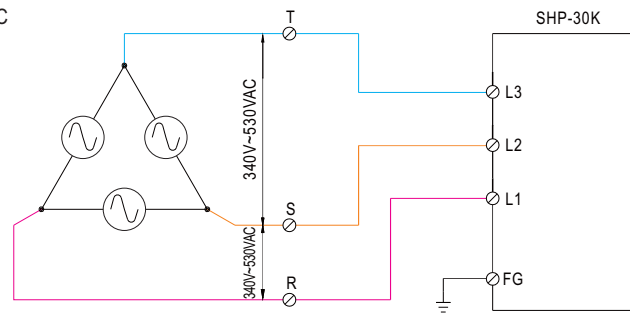

Fig 1.1

◎ 3 $\phi$  3-wire / Y 340VAC~530VAC

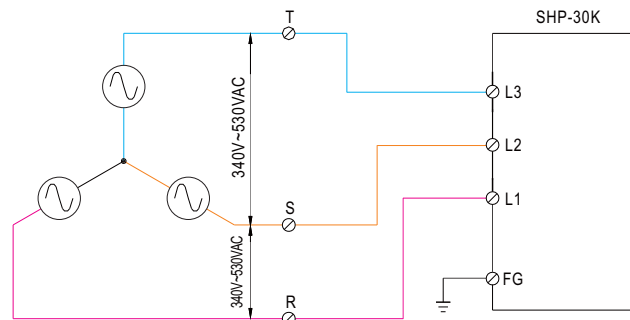



Fig 1.2



■ **Function Manual**

**1. Output Voltage Programming (or, PV / remote voltage programming / remote adjust / margin programming / dynamic voltage trim)**

(1) Default by potentiometer (SVR)

(a) Have the DIP switch position-3 set as  ON

(b) Output voltage can be trimmed by SVR.

(2) By Output Voltage Programming

(a) Have the DIP switch position-3 set as  OFF

(b) The output voltage can be trimmed to 50~120% by applying EXTERNAL VOLTAGE between PV+ and PV- on CN53.

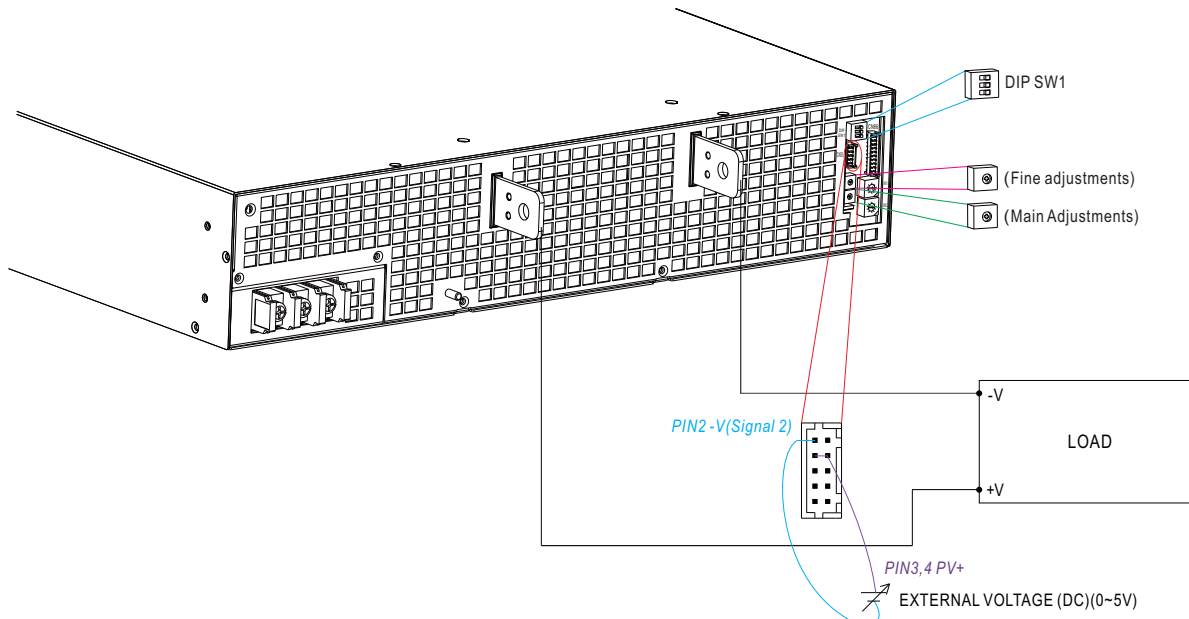
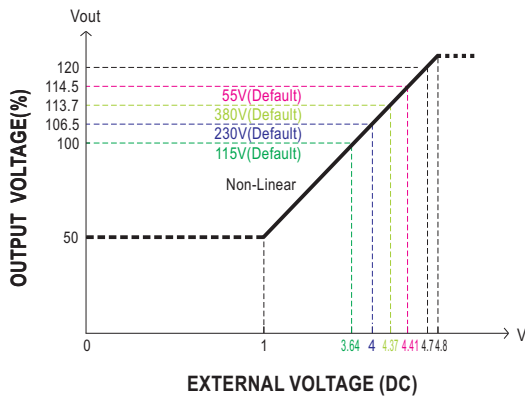
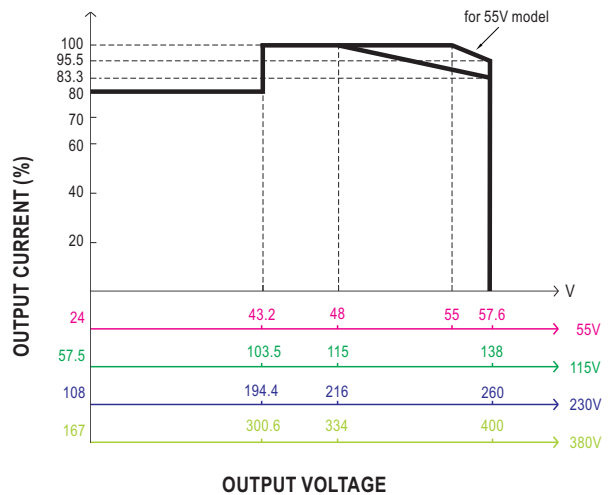

Fig 1.1



© The 100% output voltage is 48/115/216/334V.



© The rated current should change with the Output Voltage Programming accordingly.

Fig 1.2



**2.Constant Current Programming (or, PC / remote current programming / dynamic current trim)**

(1)Default Overload Protection(OLP) value

- (a)Have the DIP switch position-2 set as
- (b)Output current is set default value.



(2)By Constant Current Level Programming

- (a)Have the DIP switch position-2 set as
- (b)The constant current level can be trimmed to 1~100% of the rated current by applying EXTERNAL VOLTAGE between PC+ and PC-on CN53.

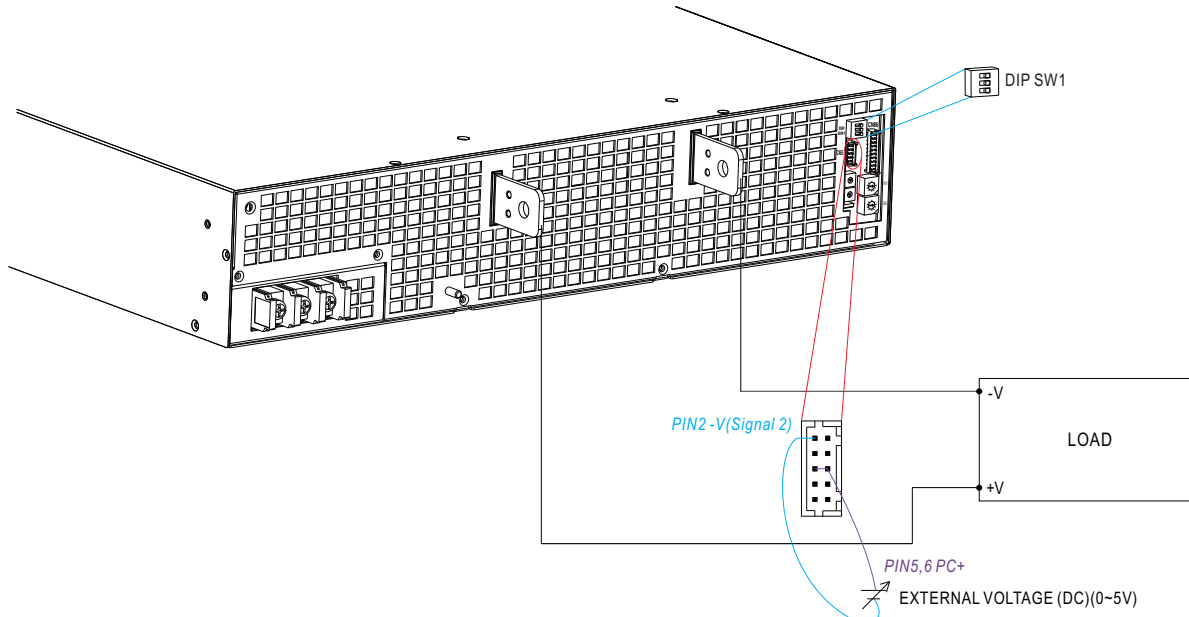

Fig 2.1

※ Under PC function at wattage < 10KW, the power supply might enter burst mode and cause output unstable, please increase the load to minimized the effect.

※ Auto de-rating function covered by over temperature protection, it works either in PC mode or under control by communication protocol.

T<sub>1</sub>(Typ.): Maximum ambient temperature of full load.

T<sub>2</sub>(Typ.): T<sub>1</sub>+5°C.

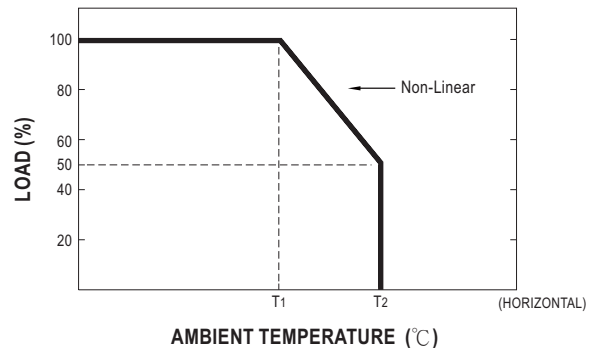
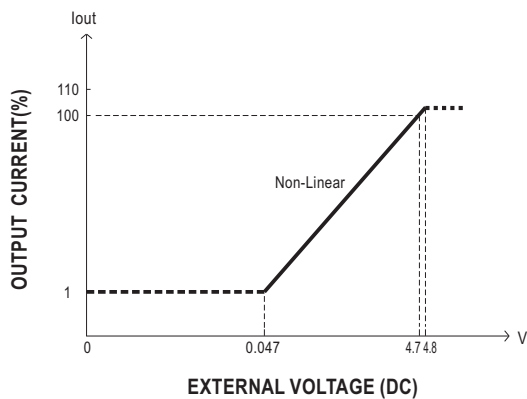

◎ The 100% output current is 346/261/139/90A.

◎ It might cause higher current ripple when the output current adjust below 20%(@<1V programming)

Fig 2.2



**3.DA, DB signal and parallel control function**

(1) Non-parallel operation

- (a) set the DIP switch of position-1 as
- (b) By default, non-parallel operation.



(2) Default parallel operation

- (a) set the DIP switch of position-1 as
- (b) PSUs are configured in parallel operation.

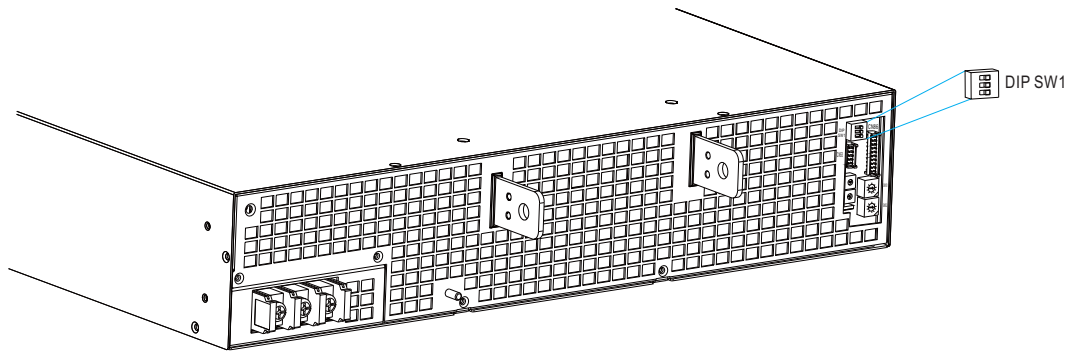

Fig 3.1

**4.Remote ON-OFF Control**

※ The power supply can be turned ON-OFF by using the "Remote ON-OFF" function.

Between Remote ON-OFF(CN86 pin3) and 5V-AUX(CN86 pin4)	Output Status
Switch close (Short)	power supply ON
Switch open (Open)	power supply OFF

Table 4.1

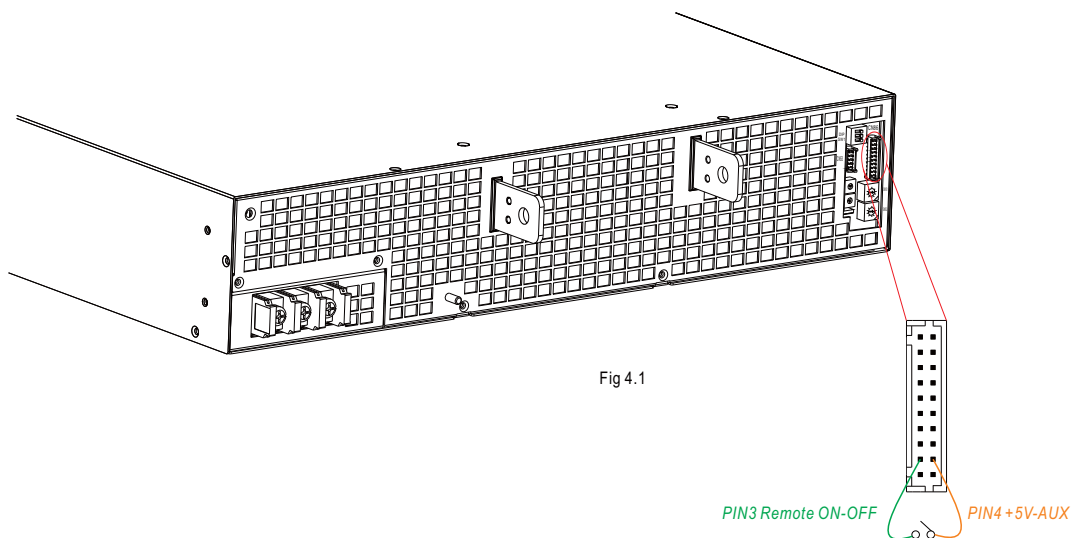

Fig 4.1



30KW 3 $\phi$  3W High Efficiency Digital Power Supply

**SHP-30K-HV** series

### 5. Alarm Signal Output

※ There are 4 alarm signals, DC-OK, T-ALARM, Fan Fail and AC-OK, in TTL signal form, on CN86. These signals are isolated from output.

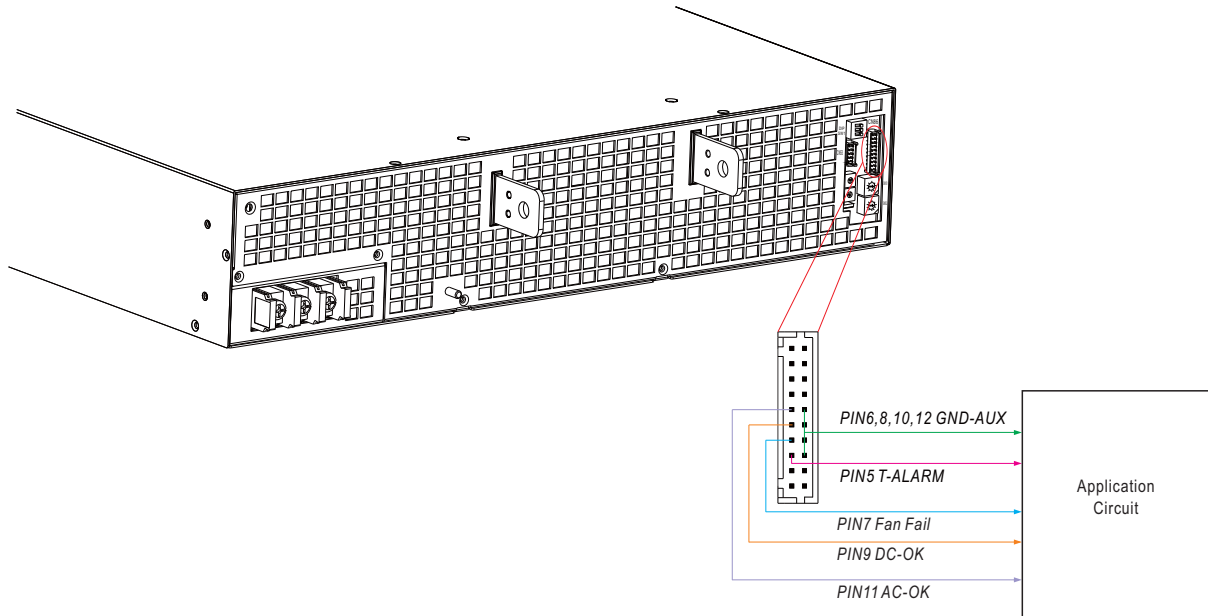

Fig 5.1

DC-OK & T-ALARM & Fan Fail Signal	Power Supply Status
"High" >3.5~5.5V	OFF
"Low" <-0.5~0.5V	ON

AC-OK Signal	Power Supply Status
"High" >3.5~5.5V	ON
"Low" <-0.5~0.5V	OFF

※ DC OK might mis-triggered when the voltage difference between PSU and the load, please minimized the unnecessary voltage difference.





# 30KW 3 φ 3W High Efficiency Digital Power Supply SHP-30K-HV series

## 6. Current Sharing

SHP-30K-HV has the built-in active current sharing function and can be connected in parallel, up to 12 units or more, to provide higher output power as exhibited below :

- ※ The power supplies should be paralleled using short and large diameter wiring and then connected to the load.
- ※ In parallel connection, power supply with the highest output Voltage will be the master unit and its Vout will be the DC bus voltage.
- ※ The total output current must not exceed the value determined by the following equation:  
 Maximum output current at parallel operation = (Rated current per unit) x (Number of unit) x 95% ; when parallel unit less than 4 units.  
 Maximum output current at parallel operation = (Rated current per unit) x (Number of unit) x [95% - (Number of unit - 4) x 2%] ; when parallel unit less than 12 units.  
 If parallel unit more than 12 units. Please contact MW sales team.
- ※ When the total output current is less than 5% of the total rated current, or say (5% of Rated current per unit) × (Number of unit) the current shared among units may not be balanced. (Please refer to the current share dreading curve)
- ※ Under parallel operation ripple of the output voltage may be higher than the SPEC at light load condition. It will go back to normal ripple level once the output load is more than 5%.

### ※ CN53/SW1 Function pin connection

Parallel	PSU1		PSU2		PSU3		PSU4		PSU5		PSU6		PSU7		PSU8		PSU9		PSU10		PSU11		PSU12	
	CN53	SW1 PIN1	CN53	SW1 PIN1	CN53	SW1 PIN1	CN53	SW1 PIN1	CN53	SW1 PIN1	CN53	SW1 PIN1	CN53	SW1 PIN1	CN53	SW1 PIN1	CN53	SW1 PIN1	CN53	SW1 PIN1	CN53	SW1 PIN1	CN53	SW1 PIN1
1 unit	X	ON	—	—	—	—	—	—	—	—	—	—	—	—	—	—	—	—	—	—	—	—	—	—
2 unit	V	ON	V	ON	—	—	—	—	—	—	—	—	—	—	—	—	—	—	—	—	—	—	—	—
3 unit	V	ON	V	OFF	V	ON	—	—	—	—	—	—	—	—	—	—	—	—	—	—	—	—	—	—
4 unit	V	ON	V	OFF	V	OFF	V	ON	—	—	—	—	—	—	—	—	—	—	—	—	—	—	—	—
5 unit	V	ON	V	OFF	V	OFF	V	OFF	V	ON	—	—	—	—	—	—	—	—	—	—	—	—	—	—
6 unit	V	ON	V	OFF	V	OFF	V	OFF	V	OFF	V	ON	—	—	—	—	—	—	—	—	—	—	—	—
7 unit	V	ON	V	OFF	V	OFF	V	OFF	V	OFF	V	OFF	V	ON	—	—	—	—	—	—	—	—	—	—
8 unit	V	ON	V	OFF	V	OFF	V	OFF	V	OFF	V	OFF	V	OFF	V	ON	—	—	—	—	—	—	—	—
9 unit	V	ON	V	OFF	V	OFF	V	OFF	V	OFF	V	OFF	V	OFF	V	OFF	V	ON	—	—	—	—	—	—
10 unit	V	ON	V	OFF	V	OFF	V	OFF	V	OFF	V	OFF	V	OFF	V	OFF	V	OFF	V	ON	—	—	—	—
11 unit	V	ON	V	OFF	V	OFF	V	OFF	V	OFF	V	OFF	V	OFF	V	OFF	V	OFF	V	OFF	V	ON	—	—
12 unit	V	ON	V	OFF	V	OFF	V	OFF	V	OFF	V	OFF	V	OFF	V	OFF	V	OFF	V	OFF	V	OFF	V	ON

(V : CN53 connected ; X : CN53 not connected.)

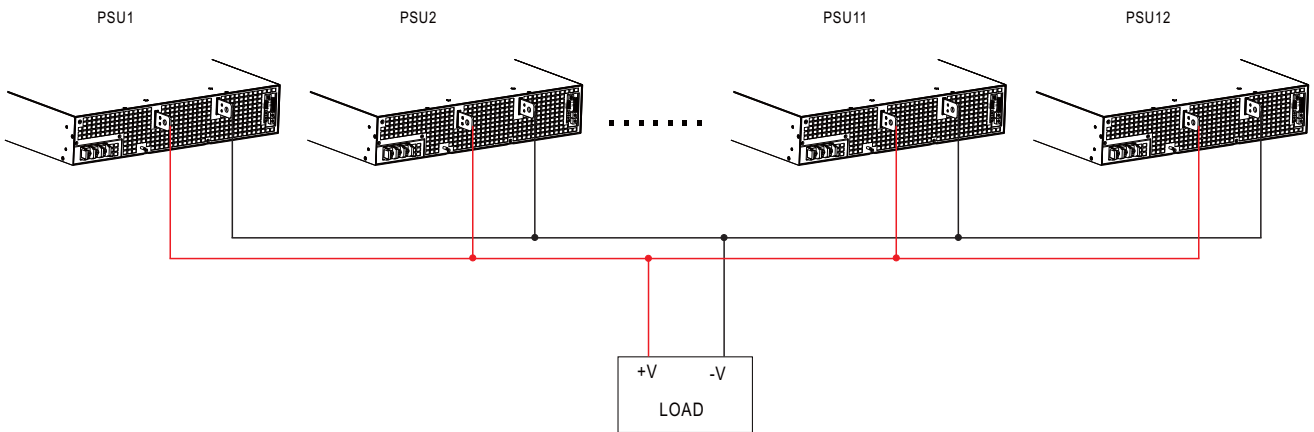
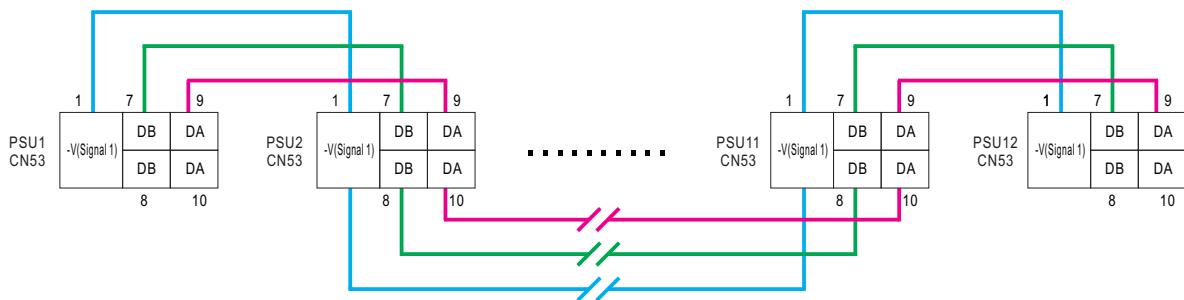

Fig 6.1



If the lines of CN53 are too long, they should be twisted in pairs to avoid the noise.

© DA, DB, -V(Signal 1) are connected mutually in parallel.



30KW 3 $\phi$  3W High Efficiency Digital Power Supply

**SHP-30K-HV** series

■ **Current Share Derating Curve**

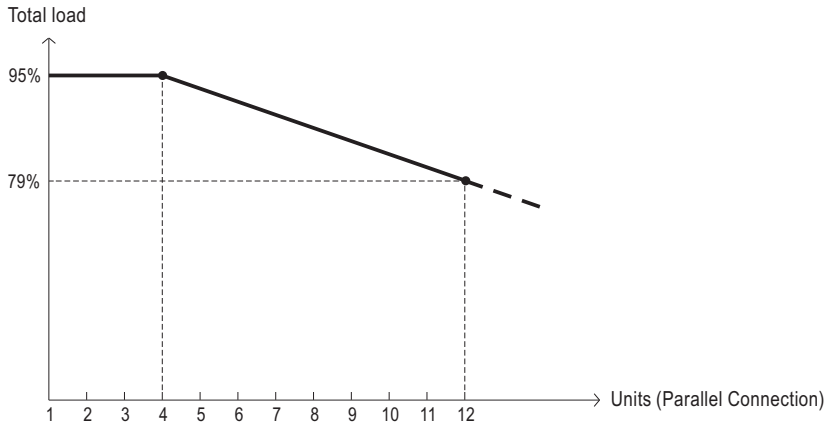

■ **Typical Application**

System power or Energy Backup System Configuration Cabinet(285KW)

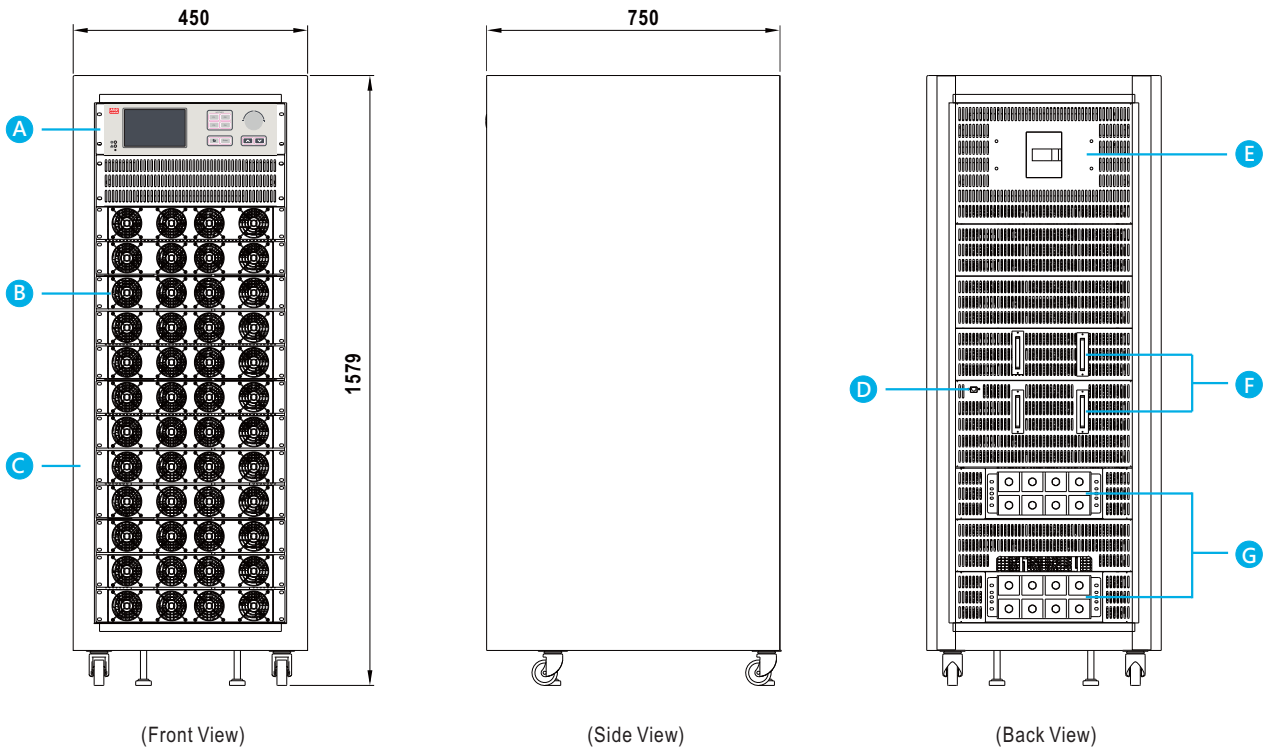

Item	Description	Item	Description
A	CMU2 Smart Controller	E	AC Input Circuit Breaker
B	SHP-30K-HV Power Supply	F	DC Output Terminal
C	30U Cabinet	G	AC Input Terminal Block
D	RJ-45 port		

© For more system power or solutions, please visit our virtual Expo C3.3 Green Technology product hall.  
 © Any further request, please contact MEAN WELL sales team.



## 30KW 3φ 3W High Efficiency Digital Power Supply

# SHP-30K-HV series

### Mechanical Specification

Case No.234B Unit:mm

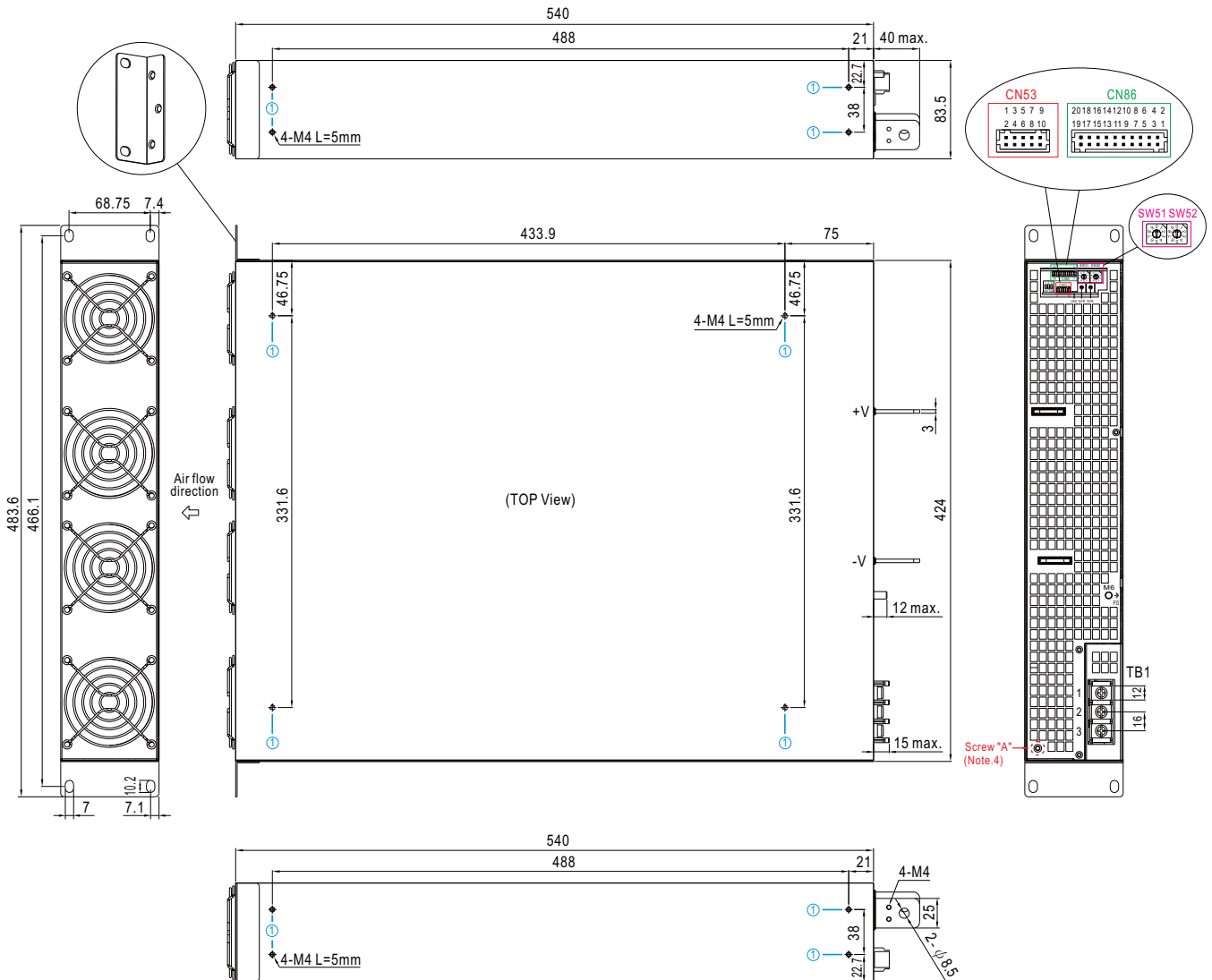

#### ※ Mounting Instruction

Hole No.	Recommended Screw Size	MAX. Penetration Depth L	Recommended mounting torque
①	M4	5mm	7~10Kgf-cm

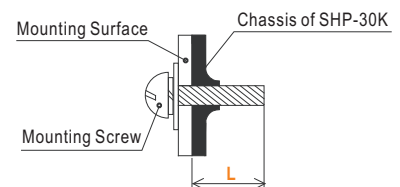

30KW 3  $\phi$  3W High Efficiency Digital Power Supply**SHP-30K-HV** series

※ Control Pin No. Assignment (CN53) : HRS DF11-10DP-2DS or equivalent

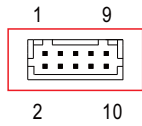

Mating Housing	HRS DF11-10DS or equivalent
Terminal	HRS DF11-10SC or equivalent

Pin No.	Function	Description
1	-V(Signal 1)	Negative output voltage signal. It is solely for parallel function; it cannot be connected directly to the load.
2	-V(Signal 2)	Negative output voltage signal. It is for PV/PC programming and certain function reference; it cannot be connected directly to the load.
3,4	PV+	Connection for output voltage programming. (Note)
5,6	PC+	Connection for constant current level programming. (Note)
7,8	DB	Differential digital signal for parallel control. (Note)
9,10	DA	Differential digital signal for parallel control. (Note)

Note: Non-isolated signal, referenced to [-V(Signal 2)].

※ Control Pin No. Assignment (CN86) : HRS DF11-20DP-2DS or equivalent

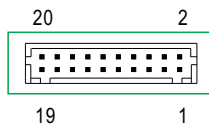

Mating Housing	HRS DF11-20DS or equivalent
Terminal	HRS DF11-20SC or equivalent

Pin No.	Function	Description
1,2	RL	Short: Termination resistors(120 $\Omega$ ) For CANBus、MODBus、Communication, please use Jumper (pin1,2)
3	Remote ON-OFF	The unit can turn the output ON/OFF by dry contact between Remote ON/OFF and +5-AUX.(Note) Short (4.5 ~ 5.5V) : Power ON ; Open(0 ~ 0.5V) : Power OFF ; The maximum input voltage is 5.5V
4	+5V-AUX	Auxiliary voltage output, 4.5~5.5V, referenced to GND-AUX (pin 6,8,10,12,19,20) only for Remote ON/OFF used. This output is not controlled by the Remote ON/OFF control.
5	T-ALARM	High (3.5 ~ 5.5V) : When the internal temperature exceeds the limit of temperature alarm. Low (-0.5 ~ 0.5V) : When the internal temperature is normal. The maximum sourcing current is 10mA and only for output.(Note)
6,8,10,12	GND-AUX	Auxiliary voltage output GND. The signal return is isolated from the output terminals (+V & -V).
7	Fan Fail	High(3.5~5.5V):When the fan fail. Low(-0.5~0.5V):When the fan works normally. The maximum sourcing current is 10mA and only for output.(Note)
9	DC-OK	High(3.5 ~ 5.5V) : When $V_{out} \leq 80\% \pm 6\%$ . Low(-0.5 ~ 0.5V) : When $V_{out} \geq 80\% \pm 6\%$ . The maximum sourcing current is 10mA and only for output.(Note)
11	AC-OK	High (3.5 ~ 5.5V): When AC input $\geq 335 \pm 1.5\%Vac$ , PSU works normally. Low (-0.5 ~ 0.5V): When AC input $\leq 320 \pm 1.5\%Vac$ , PSU shut down. The maximum sourcing current is 10mA and only for output.(Note)
13,14	SCL/CANL/ DATA-	For PMBus model: Serial Clock used in the PMBus interface.(Note) For CANBus model: Data line used in CANBus interface.(Note) For MODBus model: Data line used in MODBus interface.(Note)
15,16	SDA/CANH/ DATA+	For PMBus model: Serial Data used in the PMBus interface.(Note) For CANBus model: Data line used in CANBus interface.(Note) For MODBus model: Data line used in MODBus interface.(Note)
17,18	+12V-AUX	Auxiliary voltage output, 11.4~12.6V, referenced to GND-AUX (pin19 & 20). The maximum load current is 1.5A. This output is not controlled by "Remote ON-OFF".
19,20	GND-AUX	Auxiliary voltage output GND. The signal return is isolated from the output terminals(+V & -V).

Note: Isolated signal, referenced to (GND-AUX).



30KW 3  $\phi$  3W High Efficiency Digital Power Supply

**SHP-30K-HV** series

※ LED Status Indicators

LED	Description
Green(LED1)	LED on when output voltage is OK
Red(LED2)	LED on when any protection occurs

※ AC Input Terminal Pin No. Assignment (TB1)

Pin No.	Assignment	Diagram	Maximum mounting torque
1	AC/L1		18Kgf-cm
2	AC/L2		
3	AC/L3		

※ DIP Switch Position Assignment(DIP-SW1): Please refer to the Function Manual.

Pin No.	Assignment	Diagram
1	DA,DB Signal and paralalled control function	
2	Output Current Programming (PC)	
3	Output Voltage Programming (PV)	

※SW51 and SW52 switch

For PMBus 、CANBus 、MODBus interface address setting, please refer to the user manual for more details