



## Features

- **Global certificates**
- Universal AC input / Full range
- 3 pole AC inlet IEC320-C14, Class I power unit
- Built-in active PFC function
- No load power consumption < 0.15W
- **Energy efficiency Level VI**
- Comply with EISA 2007/DoE, NRCAN, Korea K-MEPS, AU/NZ MEPS, EU ErP and CoC Version 5
- Protections: Short circuit / Overload / Over voltage / Over temperature
- Fully enclosed plastic case
- -30~+70°C wide range working temperature
- LED indicator for power on
- **Various DC plug quick adapter accessory available**  
(Plug kit sold separately, please refer to : [https://www.meanwell.com/upload/pdf/DC\\_plug.pdf](https://www.meanwell.com/upload/pdf/DC_plug.pdf))
- 3 years warranty

## Description

GST120A is a highly reliable, 120W desktop style single-output green adaptor series. This product is a class I power unit (with FG), equipped with a standard IEC320-C14 AC inlet and adopting the input range from 85VAC to 264VAC. The entire series supplies different models with output voltages ranging between 12VDC and 48VDC that can satisfy the demands for various types of consumer electronic devices. With the efficiency up to 91% and the extremely low no-load power consumption below 0.15W, GST120A is compliant with USA EISA 2007/DoE, Canada NRCAN, Australia and New Zealand MEPS, Korea K-MEPS, EU ErP and Code of Conduct (CoC) Version 5. The supreme feature allows the adaptor to save the energy when it is either under the operating mode or the standby mode. The entire series utilizes the 94V-0 flame retardant plastic case. GST120A is certified for the international safety regulations.

## Model Encoding

**GST 120A 12 -R7B**

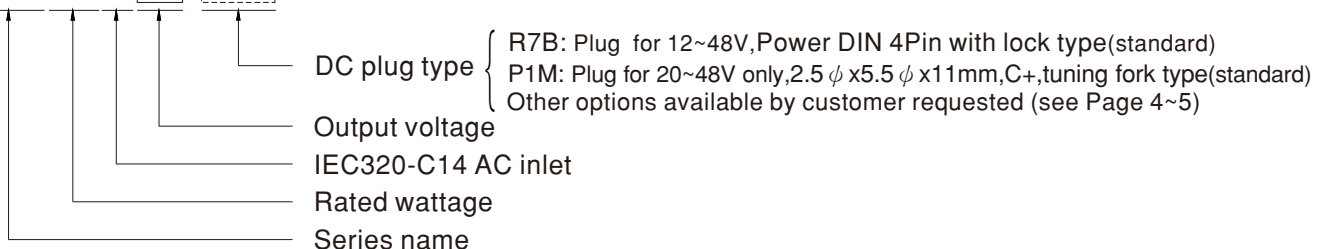

## Applications

- Consumer electronic devices
- Telecommunication devices
- Office facilities
- Industrial equipments

## GTIN CODE

MW Search: <https://www.meanwell.com/serviceGTIN.aspx>

**SPECIFICATION**

| ORDER NO.                   |   | GST120A12-R7B  | GST120A15-R7B  | GST120A20-□<br>□=R7B,P1M   | GST120A24-□<br>□=R7B,P1M                | GST120A48-□<br>□=R7B,P1M |       |
|-----------------------------|---|--|--|--|---|--------------------------|-------|
| OUTPUT                      | SAFETY MODEL NO.  | GST120A12  | GST120A15  | GST120A20  | GST120A24                               | GST120A48                |       |
|                             | DC VOLTAGE  | 12V  | 15V  | 20V  | 24V                                     | 48V                      |       |
|                             | RATED CURRENT   | 8.5A   | 7A   | 6A   | 5A                                      | 2.5A                     |       |
|                             | CURRENT RANGE   | 0 ~ 8.5A   | 0 ~ 7A   | 0 ~ 6A   | 0 ~ 5A                                  | 0 ~ 2.5A                 |       |
|                             | RATED POWER (max.)  | 102W   | 105W   | 120W   | 120W                                    | 120W                     |       |
|                             | RIPPLE & NOISE (max.) Note.2  | 120mVp-p   | 120mVp-p   | 150mVp-p   | 180mVp-p                                | 200mVp-p                 |       |
|                             | VOLTAGE TOLERANCE Note.3  | ±5.0%  | ±5.0%  | ±5.0%  | ±3.0%                                   | ±2.5%                    |       |
|                             | LINE REGULATION Note.4  | ±1.0%  | ±1.0%  | ±1.0%  | ±1.0%                                   | ±1.0%                    |       |
|                             | LOAD REGULATION   | ±5.0%  | ±5.0%  | ±4.0%  | ±3.0%                                   | ±2.5%                    |       |
|                             | SETUP, RISE TIME Note.5   | 2000ms, 30ms / 230VAC      2500ms, 30ms / 115VAC at full load  |  |  |   |                          |       |
| HOLD UP TIME (Typ.)         | 20ms / 230VAC      20ms / 115VAC at full load   |  |  |  |   |                          |       |
| INPUT                       | VOLTAGE RANGE Note.6  | 85 ~ 264VAC    120 ~ 370VDC  |  |  |   |                          |       |
|                             | FREQUENCY RANGE   | 47 ~ 63Hz  |  |  |   |                          |       |
|                             | POWER FACTOR (Typ.)   | PF>0.93 / 230VAC    PF>0.97 / 115VAC at full load  |  |  |   |                          |       |
|                             | EFFICIENCY (Typ.)   | R7B  | 88.5%  | 89%  | 90%                                     | 90.5%                    | 91%   |
|                             |   | P1M  | -----  | -----  | 89%                                     | 89.5%                    | 90.5% |
|                             | AC CURRENT  | 1.4A / 115VAC    0.7A / 230VAC   |  |  |   |                          |       |
|                             | INRUSH CURRENT (max.)   | Cold start 35 / 115AC    70A / 230VAC  |  |  |   |                          |       |
| LEAKAGE CURRENT(max.)       | 0.75mA / 240VAC   |  |  |  |   |                          |       |
| PROTECTION                  | OVERLOAD  | 105 ~ 160% rated output power<br>Protection type : Hiccup mode, recovers automatically after fault condition is removed  |  |  |   |                          |       |
|                             | OVER VOLTAGE  | 105 ~ 135% rated output voltage<br>Protection type : Shut down o/p voltage, re-power on to recover   |  |  |   |                          |       |
|                             | OVER TEMPERATURE  | Shut down o/p voltage, re-power on to recover  |  |  |   |                          |       |
| ENVIRONMENT                 | WORKING TEMP.   | -30 ~ +70°C (Refer to "Derating Curve")  |  |  |   |                          |       |
|                             | WORKING HUMIDITY  | 20% ~ 90% RH non-condensing  |  |  |   |                          |       |
|                             | STORAGE TEMP., HUMIDITY   | -40 ~ +85°C, 10 ~ 95% RH non-condensing  |  |  |   |                          |       |
|                             | TEMP. COEFFICIENT   | ±0.03% / °C (0~45°C)   |  |  |   |                          |       |
|                             | VIBRATION   | 10 ~ 500Hz, 2G 10min./1cycle, period for 60min. each along X, Y, Z axes  |  |  |   |                          |       |
| SAFETY & EMC (Note. 9)      | SAFETY STANDARDS Note. 7  | UL62368-1, CSA C22.2 No. 62368-1, TUV BS EN/EN62368-1, BSMI CNS14336, CCC GB4943.1, PSE J62368-1, AS/NZS 60950.1, BIS IS13252, KC K60950-1, EAC TP TC 004 approved |  |  |   |                          |       |
|                             | WITHSTAND VOLTAGE   | I/P-O/P: 3KVAC   |  |  |   |                          |       |
|                             | ISOLATION RESISTANCE  | I/P-O/P:100M Ohms / 500VDC / 25°C / 70% RH   |  |  |   |                          |       |
|                             | EMC EMISSION  | Parameter  | Standard   |  |   | Test Level / Note        |       |
|                             |   | Conducted emission   | BS EN/EN55032(CISPR32),FCC PART 15 / CISPR22<br>CAN ICES-3(B)/NMB-3(B),CNS13438,GB17625.1<br>EAC TP TC 020,MSIP KN32 |  |   | Class B                  |       |
|                             |   | Radiated emission  | BS EN/EN55032(CISPR32),FCC PART 15 / CISPR22<br>CAN ICES-3(B)/NMB-3(B),CNS13438,GB17625.1<br>EAC TP TC 020,MSIP KN32 |  |   | Class B                  |       |
|                             |   | Harmonic current   | BS EN/EN61000-3-2,GB9254   |  |   | Class A                  |       |
|                             |   | Voltage flicker  | BS EN/EN61000-3-3  |  |   | -----                    |       |
|                             | EMC IMMUNITY  | BS EN/EN55035  |  |  |   |                          |       |
|                             |   | Parameter  | Standard   |  |   | Test Level /Note         |       |
| ESD                         |   | BS EN/EN61000-4-2  |  |  | Level 4, 15KV air; Level 4, 8KV contact |                          |       |
| RF field susceptibility     |   | BS EN/EN61000-4-3  |  |  | Level 2, 3V/m                           |                          |       |
| EFT bursts                  |   | BS EN/EN61000-4-4  |  |  | Level 2, 1KV                            |                          |       |
| Surge susceptibility        |   | BS EN/EN61000-4-5  |  |  | Level 3, 1KV/Line-Line , 2KV/Line-FG    |                          |       |
| Conducted susceptibility    |   | BS EN/EN61000-4-6  |  |  | Level 2, 3V                             |                          |       |
| Magnetic field immunity     |   | BS EN/EN61000-4-8  |  |  | Level 2, 3A/m                           |                          |       |
| Voltage dips , interruption | BS EN/EN61000-4-11  |  |  | >95% dip 0. 5 periods, 30% dip 25 periods,<br>>95% interruptions 250 periods |   |                          |       |
| OTHERS                      | MTBF  | 2250.5K hrs min.    Telcordia SR-332 (Bellcore) ; 368.5K hrs min.    MIL-HDBK-217F (25°C)  |  |  |   |                          |       |
|                             | DIMENSION   | 167*67*35mm (L*W*H)  |  |  |   |                          |       |
|                             | PACKING   | 0.575Kg; 20pcs/12.5Kg/0.89CUFT   |  |  |   |                          |       |
| CONNECTOR                   | PLUG  | See page 4~5 ; Other type available by customer requested  |  |  |   |                          |       |
|                             | CABLE   | See page 4~5 ; Other type available by customer requested  |  |  |   |                          |       |
| NOTE                        | <p>1. All parameters are specified at 230VAC input, rated load, 25°C 70% RH ambient.</p> <p>2. Ripple &amp; noise are measured at 20MHz by using a 12" twisted pair terminated with a 0.1 μ F &amp; 47 μ F capacitor.</p> <p>3. Tolerance: includes set up tolerance, line regulation, load regulation.</p> <p>4. Line regulation is measured from low line to high line at rated load.</p> <p>5. Length of set up time is measured at first cold start. Turning ON/OFF the power supply may lead to increase of the set up time.</p> <p>6. Derating may be needed under low input voltage. Please check the derating curve for more details.</p> <p>7. The ambient temperature derating of 3.5°C/1000m with fanless models and of 5°C/1000m with fan models for operating altitude higher than 2000m(6500ft).</p> <p>8. The power supply is considered as an independent unit, but the final equipment still need to re-confirm that the whole system complies with the EMC directives. For guidance on how to perform these EMC tests, please refer to "EMI testing of component power supplies."<br/>(as available on <a href="https://www.meanwell.com/Upload/PDF/EMI_statement_en.pdf">https://www.meanwell.com/Upload/PDF/EMI_statement_en.pdf</a>)</p> <p>※ Product Liability Disclaimer : For detailed information, please refer to <a href="https://www.meanwell.com/serviceDisclaimer.aspx">https://www.meanwell.com/serviceDisclaimer.aspx</a></p> |  |  |  |   |                          |       |



120W AC-DC Reliable Green Industrial Adaptor

**GST120A** series

■ Derating Curve

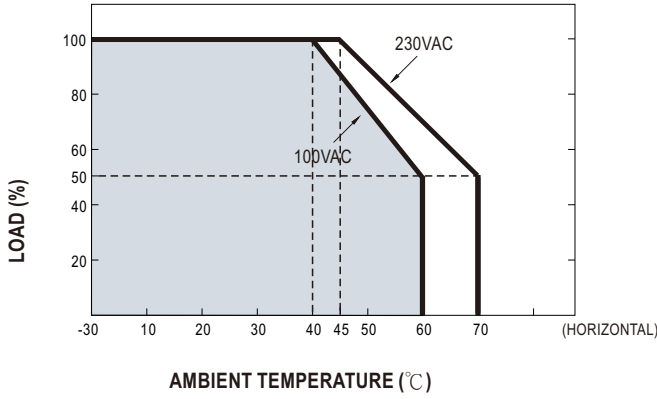

■ Static Characteristics

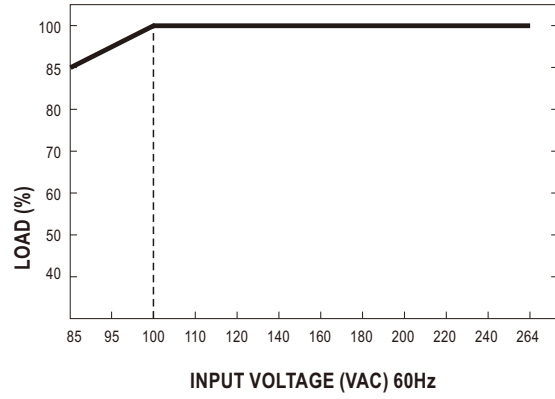

■ Mechanical Specification

(Unit: mm , tolerance ± 1mm)

Case No. GS120A

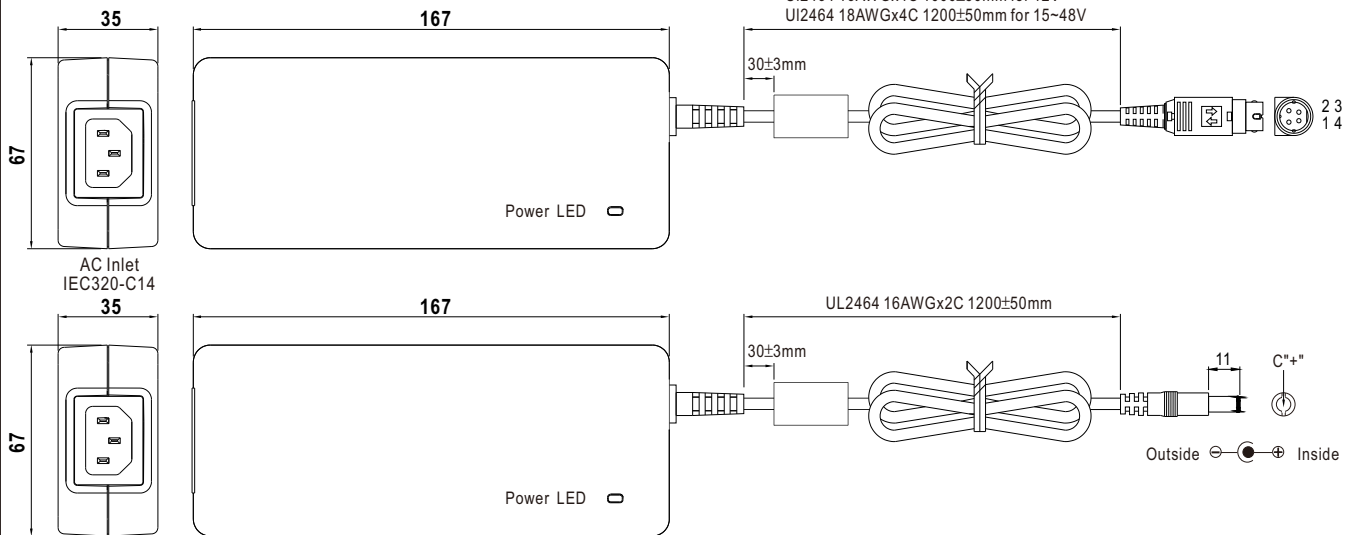

■ DC output plug

◎ Standard plug

| R7B                             |                    | Pin Assignment                                      |   |         |        |   |     |   |     |   |     |   |     |
|---------------------------------|--------------------|---|---|---------|--------|---|-----|---|-----|---|-----|---|-----|
| <p>KYCON KPPX-4P equivalent</p> | <p>2 3<br/>1 4</p> | <p>AC FG<br/>-V connected to AC FG</p>              | <table border="1"> <thead> <tr> <th>PIN NO.</th> <th>OUTPUT</th> </tr> </thead> <tbody> <tr> <td>1</td> <td>+Vo</td> </tr> <tr> <td>2</td> <td>-Vo</td> </tr> <tr> <td>3</td> <td>-Vo</td> </tr> <tr> <td>4</td> <td>+Vo</td> </tr> </tbody> </table> | PIN NO. | OUTPUT | 1 | +Vo | 2 | -Vo | 3 | -Vo | 4 | +Vo |
|                                 |                    |   | PIN NO.   | OUTPUT  |        |   |     |   |     |   |     |   |     |
|                                 |                    |   | 1   | +Vo     |        |   |     |   |     |   |     |   |     |
|                                 |                    |   | 2   | -Vo     |        |   |     |   |     |   |     |   |     |
| 3                               | -Vo                |   |   |         |        |   |     |   |     |   |     |   |     |
| 4                               | +Vo                |   |   |         |        |   |     |   |     |   |     |   |     |
| P1M                             |                    | Pin Assignment                                      |   |         |        |   |     |   |     |   |     |   |     |
| <p>5.5<br/>2.5<br/>11±0.5mm</p> | <p>C*+*</p>        | <p>Outside ⊖ ⊕ Inside<br/>-V connected to AC FG</p> |   |         |        |   |     |   |     |   |     |   |     |
|                                 |                    |   |   |         |        |   |     |   |     |   |     |   |     |

◎ DC plug changeable through:







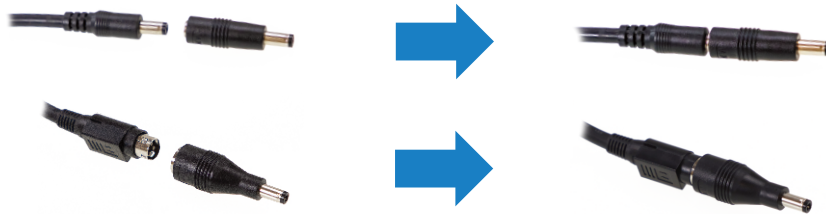

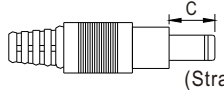
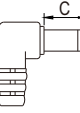

- (1) Customization of the standard part with an optional DC plug according to the table (MOQ applicable)
- (2) Quick adapter accessory (sold separately without MOQ)

Please refer to below table and online selection guide : [https://www.meanwell.com/upload/pdf/DC\\_plug.pdf](https://www.meanwell.com/upload/pdf/DC_plug.pdf)

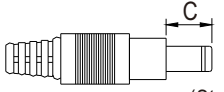
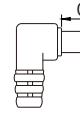

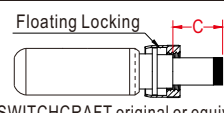
Example quick adapter accessory:

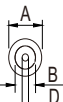
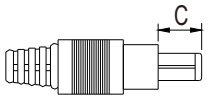

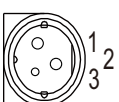
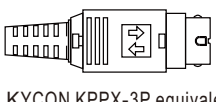
◎ Optional DC plug: (Available in customized cable or quick adapter)

| Tuning Fork Style  |   | Type No. | A              | B     | C      | Quick Adapter Accessory                               |      |
|--|---|----------|----------------|-------|--------|---|------|
|  |   |          | OD             | ID    | L      |   |      |
|  <div style="display: flex; justify-content: space-around;"> <div style="text-align: center;">  <p>A<br/>B</p> </div> <div style="text-align: center;">  <p>C<br/>(Straight)</p> </div> </div>  | P1I   | 5.5      | 2.1            | 9.5   | None   |   |      |
|  | P1L   | 5.5      | 2.5            | 9.5   |        |   |      |
|  | P1J   | 5.5      | 2.1            | 11.0  |        |   |      |
|  |  <p>C<br/>(Right-angled)</p>  | P1JR     | 5.5            | 2.1   | 11.0   | Available for 15 ~ 48V<br>(Current rating: 7.5A max.) |      |
|  |   | P1IR     | 5.5            | 2.1   | 9.5    |   |      |
|  |   | P1LR     | 5.5            | 2.5   | 9.5    |   |      |
|  |   | P1MR     | 5.5            | 2.5   | 11.0   |   |      |
|  |   | P1LR     | 5.5            | 2.5   | 9.5    |   | None |
| Barrel Style   |   | Type No. | A              | B     | C      | None  |      |
|  |   |          | OD             | ID    | L      |   |      |
|  <div style="display: flex; justify-content: space-around;"> <div style="text-align: center;">  <p>A<br/>B</p> </div> <div style="text-align: center;">  <p>C<br/>(Straight)</p> </div> </div>  | P2I   | 5.5      | 2.1            | 9.5   |        |   |      |
|  | P2J   | 5.5      | 2.1            | 11.0  |        |   |      |
|  | P2L   | 5.5      | 2.5            | 9.5   |        |   |      |
|  | P2M   | 5.5      | 2.5            | 11.0  |        |   |      |
|  |  <p>C<br/>(Right-angled)</p> | P2IR     | 5.5            | 2.1   | 9.5    |   |      |
|  |   | P2JR     | 5.5            | 2.1   | 11.0   |   |      |
|  |   | P2LR     | 5.5            | 2.5   | 9.5    |   |      |
|  |   | P2MR     | 5.5            | 2.5   | 11.0   |   |      |
| Lock Style   |   | Type No. | A              | B     | C      |   | None |
|  |   |          | OD             | ID    | L      |   |      |
|  <div style="display: flex; justify-content: space-around;"> <div style="text-align: center;">  <p>A<br/>B</p> </div> <div style="text-align: center;">  <p>Floating Locking<br/>SWITCHCRAFT original or equivalent</p> </div> </div> | P2S(S761K)  | 5.53     | 2.03           | 12.06 |        |   |      |
|  | P2K(761K)   | 5.53     | 2.54           | 12.06 |        |   |      |
|  | P2C(S760K)  | 5.53     | 2.03           | 9.52  |        |   |      |
|  | P2D(760K)   | 5.53     | 2.54           | 9.52  |        |   |      |
|  | Center Pin Style  |          | Type No.       | A     | B      | C   | D    |
|  |   |          | OD             | ID    | L      | Center Pin  |      |
|  <div style="display: flex; justify-content: space-around;"> <div style="text-align: center;">  <p>A<br/>B<br/>D</p> </div> <div style="text-align: center;">  <p>C<br/>EIAJ equivalent</p> </div> </div>                             | P4A   | 5.5      | 3.4            | 11.0  | 1.0    |   |      |
|  | P4B   | 6.5      | 4.4            | 11.0  | 1.4    |   |      |
|  | P4C   | 7.4      | 5.1            | 11.0  | 0.6    |   |      |
| Min. DIN 3 Pin with Lock (male)  |   | Type No. | Pin Assignment |       |        |   | None |
|  |   |          | PIN No.        |       | Output |   |      |
|  <div style="display: flex; justify-content: space-around;"> <div style="text-align: center;">  <p>1<br/>2<br/>3</p> </div> <div style="text-align: center;">  <p>KYCON KPPX-3P equivalent</p> </div> </div>                          | R6B   | 1        | +Vo            |       |        |   |      |
|  | 2   | -Vo      |                |       |        |   |      |
|  | 3   | +Vo      |                |       |        |   |      |

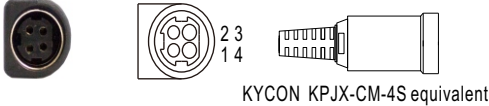

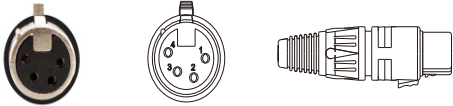
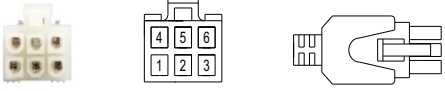
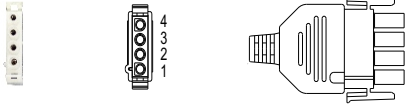
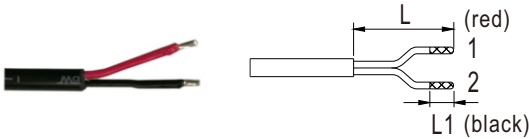
| Min. DIN 4 Pin with Lock (female)  | Type No.    | Pin Assignment |        | Quick Adapter Accessory |
|--|-------------|----------------|--------|-------------------------|
|  |             | PIN No.        | Output |                         |
|  <p>KYCON KPJX-CM-4S equivalent</p>   | R7BF        | 1              | +Vo    | None                    |
|  |             | 2              | -Vo    |                         |
|  |             | 3              | -Vo    |                         |
|  |             | 4              | +Vo    |                         |
| DIN 5 Pin (male)   | Type No.    | Pin Assignment |        |                         |
|  |             | PIN No.        | Output |                         |
|   | R1B         | 1              | -Vo    | None                    |
|  |             | 2              | -Vo    |                         |
|  |             | 3              | +Vo    |                         |
|  |             | 4              | -Vo    |                         |
|  |             | 5              | +Vo    |                         |
| NEUTRIK XLR NC4FX equivalent   | Type No.    | Pin Assignment |        |                         |
|  |             | PIN No.        | Output |                         |
|   | MIC4        | 1              | +Vo    | None                    |
|  |             | 2              | +Vo    |                         |
|  |             | 3              | -Vo    |                         |
|  |             | 4              | -Vo    |                         |
| MOLEX 39-01-2060 (4.2mm) equivalent  | Type No.    | Pin Assignment |        |                         |
|  |             | PIN No.        | Output |                         |
|   | C6P         | 1              | +Vo    | None                    |
|  |             | 2              | +Vo    |                         |
|  |             | 3              | +Vo    |                         |
|  |             | 4              | -Vo    |                         |
|  |             | 5              | -Vo    |                         |
|  |             | 6              | -Vo    |                         |
| AMP 1-480702-0 (6.35mm) equivalent   | Type No.    | Pin Assignment |        |                         |
|  |             | PIN No.        | Output |                         |
|   | C4P         | 1              | +Vo    | None                    |
|  |             | 2              | +Vo    |                         |
|  |             | 3              | -Vo    |                         |
|  |             | 4              | -Vo    |                         |
| Stripped and tinned leads  | Type No.    | Pin Assignment |        |                         |
|  |             | PIN No.        | Output |                         |
|  <p>Length of Land L1 by request<br/>(MW's standard length, L: <u>25</u> mm, L1: <u>5</u> mm)<br/>( NOTE: The wire color is for reference only,<br/>please refer to the actual product)</p> | by customer | 1              | +Vo    | None                    |
|  |             | 2              | -Vo    |                         |

■ Installation Manual

Please refer to : <http://www.meanwell.com/manual.html>