



600W Ultra-High Peak Power Supply

HRP-600N3 series



User's Manual



■ Features

- Universal AC input / Full range
- Withstand 300VAC surge input for 5 seconds
- Up to 350% peak power capability
- Built-in constant current limiting circuit
- Protections: Short circuit / Overload / Over voltage / Over temperature
- Built-in cooling fan ON-OFF control
- Built-in DC OK signal
- Built-in remote sense function
- Withstand 5G vibration
- Operating altitude up to 5000 meters(Note.5)
- Output voltage adjustable $\pm 15\%$ (Avg.)
- 5 years warranty

■ Applications

- Industrial automation machinery
- Industrial control system
- Mechanical and electrical equipment
- Diagnostic or biological facilities
- Test or measurement systems
- Telecommunication equipment

■ GTIN CODE

MW Search: <https://www.meanwell.com/serviceGTIN.aspx>

■ Description

HRP-600N3 series is a 600W single output AC/DC ultra-high peak power supply. This series operates at 85~264VAC input voltage and offers the models with the DC output mostly demanded from the industry. Each model is cooled by the built-in fan with fan ON-OFF control, working for the temperature up to 70°C. Moreover, HRP-600N3 can provide 350% short-duration peak power for motor applications and electromechanical loads requiring much higher power during start-up.

■ Model Encoding

HRP - 600N3 - 24

Output voltage(12/24/36/48V)
3.5 times peak power
Rated wattage
Series name



600W Ultra-High Peak Power Supply

HRP-600N3 series

SPECIFICATION

MODEL	HRP-600N3-12	HRP-600N3-24	HRP-600N3-36	HRP-600N3-48	
OUTPUT	DC VOLTAGE	12V	24V	36V	48V
	RATED CURRENT	53A	27A	17.5A	13A
	CURRENT RANGE	0 ~ 53A	0 ~ 27A	0 ~ 17.5A	0 ~ 13A
	RATED POWER	636W	648W	630W	624W
	RIPPLE & NOISE (max.) Note.2	200mVp-p	150mVp-p	200mVp-p	240mVp-p
	VOLTAGE ADJ. RANGE	10.2 ~ 13.8V	21.6 ~ 28.8V	28.8 ~ 39.6V	40.8 ~ 55.2V
	VOLTAGE TOLERANCE Note.3	±1.0%	±1.0%	±1.0%	±1.0%
	LINE REGULATION	±0.3%	±0.2%	±0.2%	±0.2%
	LOAD REGULATION	±0.5%	±0.5%	±0.5%	±0.5%
	SETUP, RISE TIME	1800ms, 50ms/230VAC 3600ms, 50ms/115VAC at full load			
HOLD UP TIME (Typ.)	16ms/230VAC 16ms/115VAC at full load				
INPUT	VOLTAGE RANGE Note.4	85 ~ 264VAC 120 ~ 370VDC			
	FREQUENCY RANGE	47 ~ 63Hz			
	POWER FACTOR (Typ.)	PF>0.94/230VAC PF>0.98/115VAC at full load			
	EFFICIENCY (Typ.)	88%	88%	89%	89%
	AC CURRENT (Typ.)	7.6A/115VAC 3.6A/230VAC			
	INRUSH CURRENT (Typ.)	35A/115VAC 70A/230VAC			
LEAKAGE CURRENT	<2mA / 240VAC				
PROTECTION	OVERLOAD	Output power >105% rated for more than 5 seconds then shut down o/p voltage, re-power on to recover Constant current limiting for output power >380% rated for more than 5 seconds and then shut down o/p voltage, re-power on to recover			
	OVER VOLTAGE	14.4 ~ 16.8V	30 ~ 34.8V	41.4 ~ 48.6V	57.6 ~ 67.2V
	OVER TEMPERATURE	Shut down o/p voltage, recovers automatically after temperature goes down Protection type : Shut down o/p voltage, re-power on to recover			
FUNCTION	DC OK SIGNAL	PSU turn on : 3.3 ~ 5.6V ; PSU turn off : 0 ~ 1V			
	FAN CONTROL (Typ.)	Load 35 ± 15% or RTH2 ≥ 50°C Fan on			
ENVIRONMENT	WORKING TEMP.	-40 ~ +70°C (Refer to "Derating Curve")			
	WORKING HUMIDITY	20 ~ 90% RH non-condensing			
	STORAGE TEMP., HUMIDITY	-40 ~ +85°C, 10 ~ 95% RH non-condensing			
	TEMP. COEFFICIENT	±0.03%/°C (0 ~ 50°C)			
	VIBRATION	10 ~ 500Hz, 5G 10min./1cycle, 60min. each along X, Y, Z axes			
OPERATING ALTITUDE Note.5	5000 meters				
SAFETY & EMC (Note 6)	SAFETY STANDARDS	UL62368-1, TUV BS EN/EN62368-1, EAC TP TC 004, AS/NZS 62368.1 approved			
	WITHSTAND VOLTAGE	I/P-O/P:3KVAC I/P-FG:2KVAC O/P-FG:0.5KVAC			
	ISOLATION RESISTANCE	I/P-O/P, I/P-FG, O/P-FG:100M Ohms / 500VDC / 25°C / 70% RH			
	EMC EMISSION	Parameter	Standard		Test Level / Note
		Conducted	BS EN/EN55032		Class B
		Radiated	BS EN/EN55032		Class B
		Harmonic current	BS EN/EN61000-3-2		Class A
		Voltage Flicker	BS EN/EN61000-3-3		----
	EMC IMMUNITY	BS EN/EN55035, BS EN/EN61000-6-2(BS EN/EN50082-2)			
		Parameter	Standard		Test Level / Note
ESD		BS EN/EN61000-4-2		Level 3, 8KV air; Level 2, 4KV contact	
RF field		BS EN/EN61000-4-3		Level 3, 10V/m	
EFT/ Burst		BS EN/EN61000-4-4		Level 3, 2KV	
Surge		BS EN/EN61000-4-5		Level 4, 4KV/Line-FG; 2KV/Line-Line	
Conducted		BS EN/EN61000-4-6		Level 3, 10V	
Magnetic Field		BS EN/EN61000-4-8		Level 4, 30A/m	
Voltage Dips and Interruptions	BS EN/EN61000-4-11		95% dip 0.5 periods, 30% dip 25 periods, 95% interruptions 250 periods		
OTHERS	MTBF	1380.2K hrs min. Telcordia TR/SR-332 (Bellcore) ; 191.8K hrs min. MIL-HDBK-217F (25°C)			
	DIMENSION	218*105*61.5mm (L*W*H)			
	PACKING	1.39Kg;8pcs/12.1Kg/1.58CUFT			
NOTE	<p>1. All parameters NOT specially mentioned are measured at 230VAC input, rated load and 25°C of ambient temperature.</p> <p>2. Ripple & noise are measured at 20MHz of bandwidth by using a 12" twisted pair-wire terminated with a 0.1 μF & 47 μF parallel capacitor.</p> <p>3. Tolerance : includes set up tolerance, line regulation and load regulation.</p> <p>4. Derating may be needed under low input voltages. Please check the derating curve for more details.</p> <p>5. The ambient temperature derating of 3.5°C/1000m with fanless models and of 5°C/1000m with fan models for operating altitude higher than 2000m(6500ft).</p> <p>6. The power supply is considered a component which will be installed into a final equipment. All the EMC tests are been executed by mounting the unit on a 360mm*360mm metal plate with 1mm of thickness. The final equipment must be re-confirmed that it still meets EMC directives. For guidance on how to perform these EMC tests, please refer to "EMI testing of component power supplies." (as available on https://www.meanwell.com/Upload/PDF/EMI_statement_en.pdf)</p> <p>※ Product Liability Disclaimer : For detailed information, please refer to https://www.meanwell.com/serviceDisclaimer.aspx</p>				



600W Ultra-High Peak Power Supply

HRP-600N3 series

■ **Block Diagram**

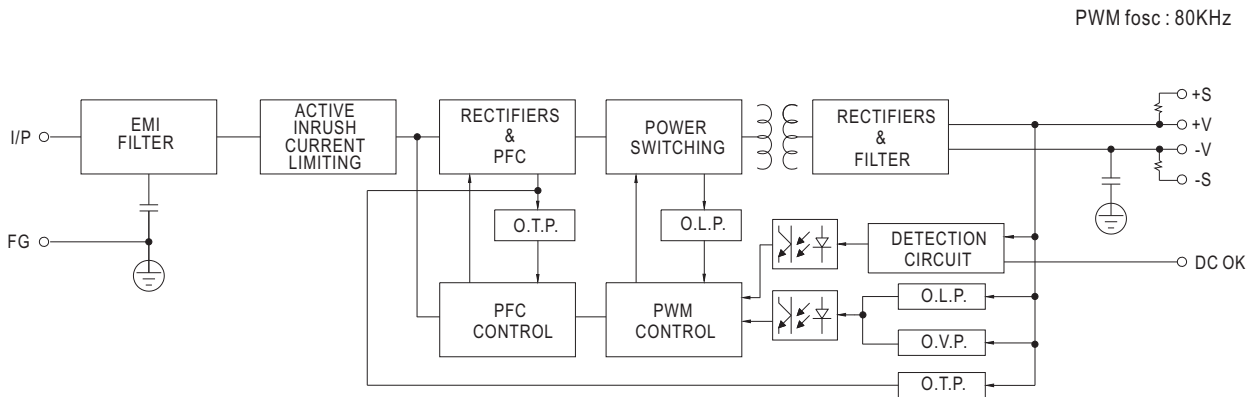

■ **Derating Curve**

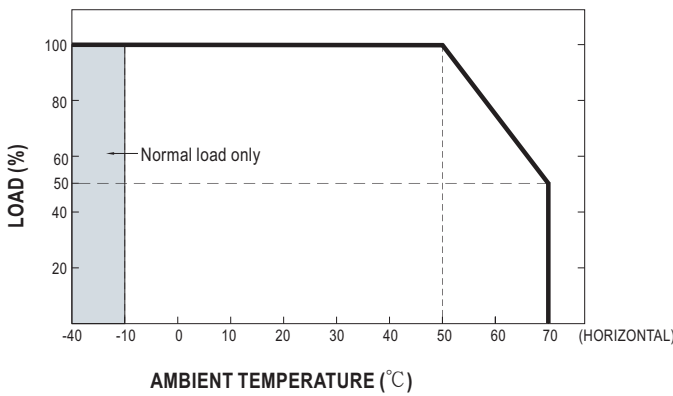

■ **Output Derating VS Input Voltage**

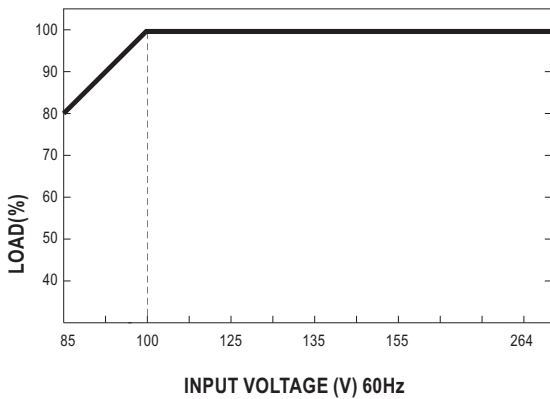



■ Function Manual

1. Peak Power

$$P_{av} = \frac{P_{pk} \times t + P_{npk} \times (T-t)}{T} \leq P_{rated}$$

$$Duty = \frac{t}{T} \times 100\% \leq 35\%$$

P_{av} : Average output power (W)

P_{pk} : Peak output power (W)

P_{npk} : Non-peak output power (W)

P_{rated} : Rated output power (W)

t : Peak power width (sec)

T : Period (sec)

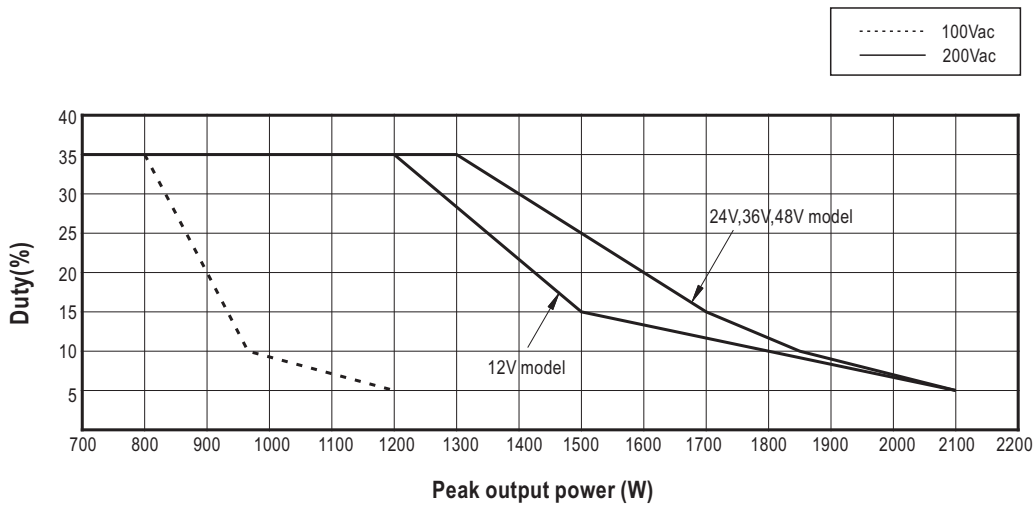
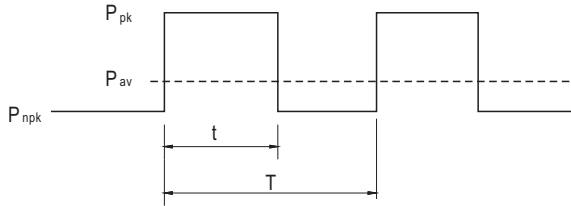

For example (24V model) :

$V_{in} = 200V$ $Duty_{max} = 25\%$

$P_{av} = P_{rated} = 648W$

$P_{pk} = 1500W$

$t \leq 5 \text{ sec}$

$T \geq \frac{5 \text{ sec}}{25\%} \geq 20 \text{ sec}$

$$P_{nPk} \leq \frac{T P_{av} - t P_{pk}}{T-t}$$

$P_{nPk} \leq 364W$



2. Remote Sense

The remote sensing compensates voltage drop on the load wiring up to 0.5V.

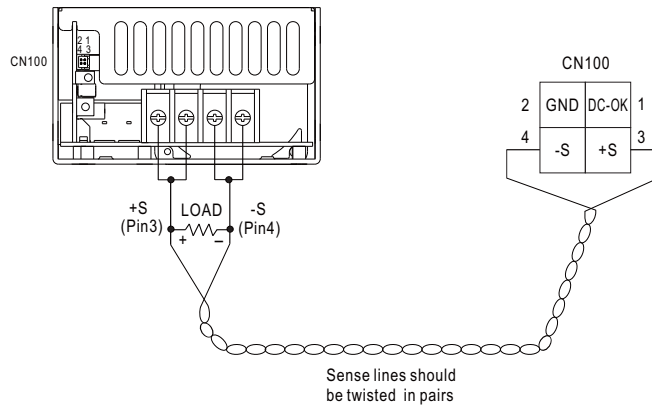

Fig 1.1

3. DC-OK Signal

DC-OK signal is a TTL level signal. High when PSU turns on.

Between DC-OK(pin1) and GND(pin2)	Output Status
3.3 ~ 5.6V	ON
0 ~ 1V	OFF

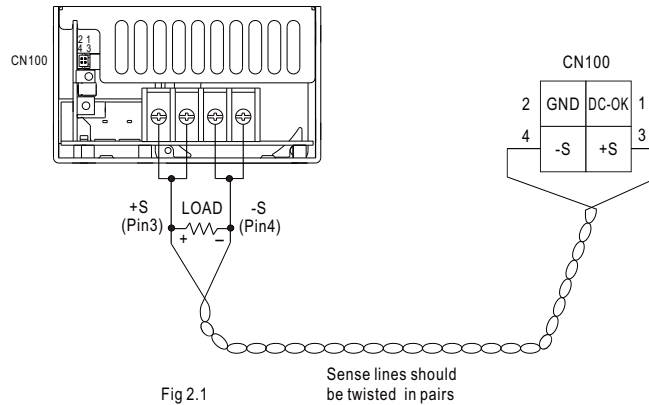

Fig 2.1



600W Ultra-High Peak Power Supply

HRP-600N3 series

■ Mechanical Specification

(Unit: mm , tolerance ± 1mm)

Case No. 977G

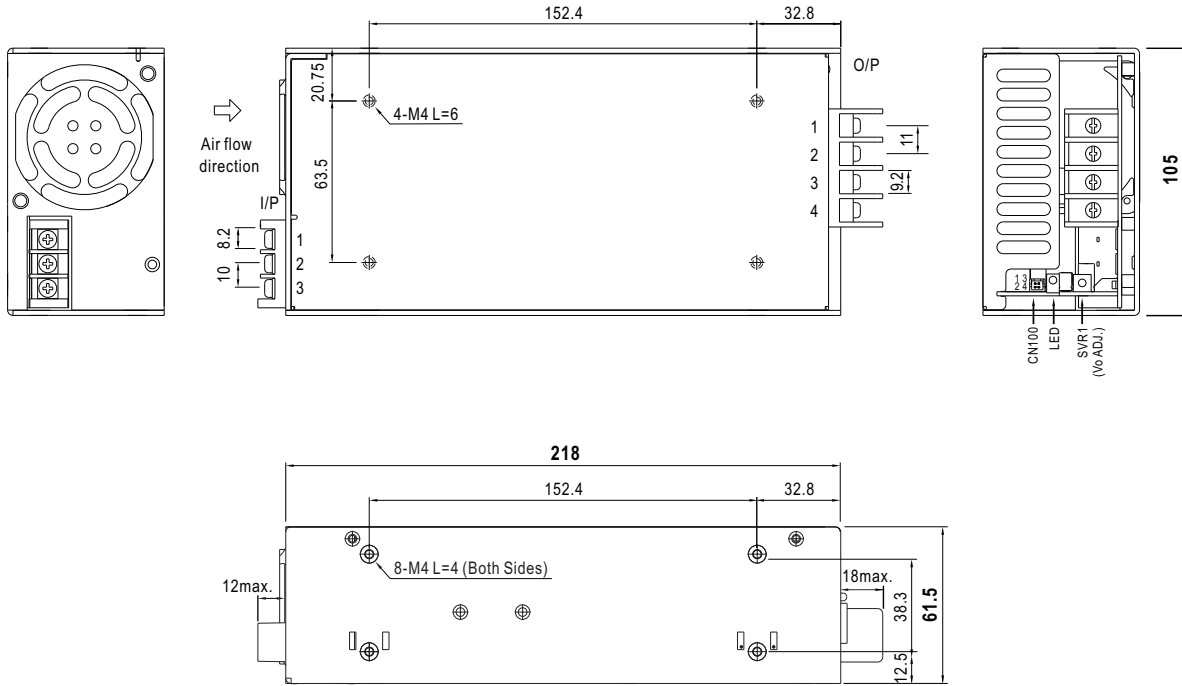

AC Input Terminal Pin No. Assignment

Pin No.	Assignment
1	AC/L
2	AC/N
3	FG \perp

DC Output Terminal Pin No. Assignment

Pin No.	Assignment
1~2	-V
3~4	+V

Connector Pin No. Assignment(CN100) : HRS DF11-4DP-2DS or equivalent

Pin No.	Assignment	Mating Housing	Terminal
1	DC-OK	HRS DF11-4DS or equivalent	HRS DF11-**SC or equivalent
2	GND		
3	+S		
4	-S		

■ Installation Manual

Please refer to : <http://www.meanwell.com/manual.html>