



500W Slim Type with PFC Switching Supply

**UHP-500** series



## ■ Features

- Slim and Low profile (31mm)
- Fanless design,500W convection
- Withstand 300VAC surge input for 5 seconds
- Built-in active PFC function
- -30~+70°C working temperature
- Protections: Short circuit / Overload / Over voltage / Over temperature
- DC OK active signal and redundant function(option)
- Operating altitude up to 5000 meter (Note.5)
- LED indicator for power on
- 3 years warranty

## ■ Applications

- Industrial automation machinery
- Industrial control system
- Mechanical and electrical equipment
- Electronic instruments, equipments or apparatus
- LED display application
- Power Source Equipment for PoE(55V model)

## ■ GTIN CODE

MW Search: <https://www.meanwell.com/serviceGTIN.aspx>

## ■ Description

UHP-500 series is a 500W single-output slim type power supply with 31 mm of low profile design. Adopting the full range 90~264VAC input, the entire series provides an output voltage line of 4.2V, 5V, 12V, 15V, 24V, 36V, 48V and 55V. In addition to the high efficiency up to 95%, that the whole series operates from -30°C ~ 70°C under air convection without fan. UHP-500 has the complete protection functions and 5G anti-vibration capability; It is complied with the international safety regulations such as TUV BS EN/EN62368-1, BS EN/EN60335-1, UL 62368-1 and GB 4943.1. UHP-500 series serves as a high performance power supply solution for various industrial applications.

## ■ Model Encoding

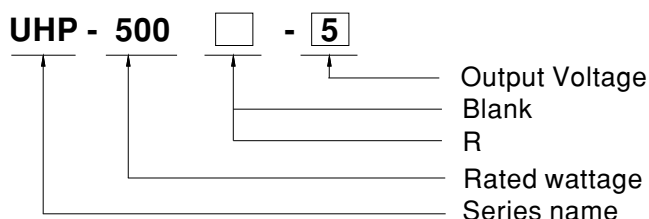

| Type  | Description   | Note       |
|-------|---|------------|
| Blank | Enclosed  | In Stock   |
| R     | Buit-in DC OK active signal and redundant function. | By request |



500W Slim Type with PFC Switching Supply

UHP-500 series

## SPECIFICATION

| MODEL                 |  | UHP-500□-4.2  | UHP-500□-5   | UHP-500□-12  | UHP-500□-15  | UHP-500□-24  | UHP-500□-36  | UHP-500□-48  | UHP-500□-55 |  |
|-----------------------|--|---|--------------|--------------|--------------|--------------|--------------|--------------|-------------|--|
| OUTPUT                | DC VOLTAGE   | 4.2V  | 5V           | 12V          | 15V          | 24V          | 36V          | 48V          | 55V         |  |
|                       | RATED CURRENT  | 80A   | 80A          | 41.7A        | 33.4A        | 20.9A        | 13.9A        | 10.45A       | 8.9A        |  |
|                       | RATED POWER  | 336W  | 400W         | 500.4W       | 501W         | 501.6W       | 500.4W       | 501.6W       | 500W        |  |
|                       | RIPPLE & NOISE (max.) Note.2   | 200mVp-p  | 200mVp-p     | 200mVp-p     | 200mVp-p     | 240mVp-p     | 360mVp-p     | 360mVp-p     | 500mVp-p    |  |
|                       | VOLTAGE ADJ. RANGE Note.7  | 3.6~4.4V  | 4.5~5.5V     | 11.4~12.6V   | 14.3~15.8V   | 22.8~25.2V   | 34.2~37.8V   | 45.6~50.4V   | 45~58V      |  |
|                       | VOLTAGE TOLERANCE Note.3   | ±2.0%   | ±2.0%        | ±1.0%        | ±1.0%        | ±1.0%        | ±1.0%        | ±1.0%        | ±1.0%       |  |
|                       | LINE REGULATION  | ±0.5%   | ±0.5%        | ±0.3%        | ±0.3%        | ±0.3%        | ±0.3%        | ±0.3%        | ±0.3%       |  |
|                       | LOAD REGULATION  | ±1.0%   | ±1.0%        | ±0.5%        | ±0.5%        | ±0.5%        | ±0.5%        | ±0.5%        | ±0.5%       |  |
|                       | SETUP, RISE TIME   | 1000ms, 50ms/230VAC; 1000ms,50ms/115VAC at full load;550ms/230VAC for 55V setup time  |              |              |              |              |              |              |             |  |
|                       | HOLD UP TIME (Typ.)  | 12ms/230VAC   |              | 12ms/115VAC  |              |              |              |              |             |  |
| INPUT                 | VOLTAGE RANGE Note.4   | 90 ~ 264VAC   |              | 127 ~ 370VDC |              |              |              |              |             |  |
|                       | FREQUENCY RANGE  | 47 ~ 63Hz   |              |              |              |              |              |              |             |  |
|                       | POWER FACTOR (Typ.)  | PF ≥ 0.95/230VAC PF ≥ 0.98/115VAC at full load  |              |              |              |              |              |              |             |  |
|                       | EFFICIENCY (Typ.)  | 89%   | 90%          | 94%          | 94%          | 94.5%        | 95%          | 95%          | 95%         |  |
|                       | AC CURRENT (Typ.)  | 4.85A/115VAC  |              | 2.6A/230VAC  |              |              |              |              |             |  |
|                       | INRUSH CURRENT (Typ.)Note9   | Cold start 30A/115VAC   |              | 60A/230VAC   |              |              |              |              |             |  |
|                       | LEAKAGE CURRENT  | <0.75mA / 240VAC  |              |              |              |              |              |              |             |  |
| PROTECTION            | OVERLOAD   | 110~140% rated output power<br>Protection type : Hiccup mode, recovers automatically after fault condition is removed   |              |              |              |              |              |              |             |  |
|                       | OVER VOLTAGE   | 4.62 ~ 5.46V  | 5.75 ~ 6.75V | 13.2 ~ 15.6V | 16.5 ~ 19.5V | 26.4 ~ 31.2V | 39.6 ~ 46.8V | 52.8 ~ 62.4V | 60 ~ 69V    |  |
|                       |  | Protection type : Shut down O/P voltage, re-power on to recover   |              |              |              |              |              |              |             |  |
|                       | OVER TEMPERATURE   | Protection type : Shut down O/P voltage, recovers automatically after temperature goes down   |              |              |              |              |              |              |             |  |
| FUNCTION              | DC OK SIGNAL(Optional)   | Contact rating(max.):30Vdc/1A resistive load  |              |              |              |              |              |              |             |  |
|                       | REDUNDANT(Optional)  | For parallel connection protection:For parallel applications, when one PSU can not work , the another one will be automatically enabled. This can prevent the system crash, and provide the reliability of system |              |              |              |              |              |              |             |  |
| ENVIRONMENT           | WORKING TEMP.  | -30 ~ +70°C (Refer to "Derating Curve")   |              |              |              |              |              |              |             |  |
|                       | WORKING HUMIDITY   | 20 ~ 95% RH non-condensing  |              |              |              |              |              |              |             |  |
|                       | STORAGE TEMP., HUMIDITY  | -40 ~ +85°C, 10 ~ 95% RH non-condensing   |              |              |              |              |              |              |             |  |
|                       | TEMP. COEFFICIENT  | ±0.03%/°C (0 ~ 50°C)  |              |              |              |              |              |              |             |  |
|                       | VIBRATION  | 10 ~ 500Hz, 5G 10min./1cycle, 60min. each along X, Y, Z axes  |              |              |              |              |              |              |             |  |
| SAFETY & EMC (Note.6) | SAFETY STANDARDS   | UL 62368-1,TUV BS EN/EN62368-1,BS EN/EN60335-1(Except for 55V), BS EN/EN61558-1,BS EN/EN61558-2-16, GB 4943.1, BSMI CNS15598-1, EAC TP TC 004 approved;Design refer to AS/NZS 61558.1/2.16, AS/NZS 62368.1        |              |              |              |              |              |              |             |  |
|                       | WITHSTAND VOLTAGE  | I/P-O/P:3.75KVAC I/P-FG:2KVAC O/P-FG:1.25KVAC   |              |              |              |              |              |              |             |  |
|                       | ISOLATION RESISTANCE   | I/P-O/P, I/P-FG,O/P-FG:100M Ohms/500VDC/25°C / 70%RH  |              |              |              |              |              |              |             |  |
|                       | EMC EMISSION   | Compliance to BS EN/EN55032,GB17625.1,GB/T 9254.1,Class B, BS EN/EN61000-3-2,-3, BSMI CNS15936, EAC TP TC 020   |              |              |              |              |              |              |             |  |
|                       | EMC IMMUNITY   | Compliance to BS EN/EN61000-4-2,3,4,5,6,8,11;BS EN/EN61000-6-2 (BS EN/EN50082-2),BS EN/EN55035, heavy industry level ,EAC TP TC 020   |              |              |              |              |              |              |             |  |
| OTHERS                | MTBF   | 1264.1 K hrs min. Telcordia SR-332 (Bellcore) ; 167.6K hrs min. MIL-HDBK-217F (25°C)  |              |              |              |              |              |              |             |  |
|                       | DIMENSION  | 232*81*31mm (L*W*H)   |              |              |              |              |              |              |             |  |
|                       | PACKING  | 0.905kg; 16pcs/15.48kg/0.82CUFT   |              |              |              |              |              |              |             |  |
| NOTE                  | <ol style="list-style-type: none"> <li>All parameters NOT specially mentioned are measured at 230VAC input, rated load and 25°C of ambient temperature.</li> <li>Ripple &amp; noise are measured at 20MHz of bandwidth by using a 12" twisted pair-wire terminated with a 0.1uf &amp; 47uf parallel capacitor.</li> <li>Tolerance includes set up tolerance, line regulation and load regulation.</li> <li>Derating may be needed under low input voltages. Please check the derating curve for more details.</li> <li>The ambient temperature derating of 3.5°C/1000m is needed for operating altitude greater than 2000m(6500ft)</li> <li>The power supply is considered a component which will be installed into a final equipment. The final equipment must be re-confirmed that it still meets EMC directives. For guidance on how to perform these EMC tests, please refer to "EMI testing of component power supplies." (as available on <a href="https://www.meanwell.com/Upload/PDF/EMI_statement_en.pdf">https://www.meanwell.com/Upload/PDF/EMI_statement_en.pdf</a>)</li> <li>Please refer to derating curve.</li> <li>R type efficiency slightly less than the Blank type, according to the actual measurement.</li> <li>Inrush current parameter has 10% tolerance.</li> <li>RCM is on voluntary basis and meets relevant IEC or AS/NZS standards complying with AS/NZS 4417.1.</li> </ol> <p>※ Product Liability Disclaimer : For detailed information, please refer to <a href="https://www.meanwell.com/serviceDisclaimer.aspx">https://www.meanwell.com/serviceDisclaimer.aspx</a></p> |   |              |              |              |              |              |              |             |  |



500W Slim Type with PFC Switching Supply

**UHP-500 series**

■ **Block Diagram**

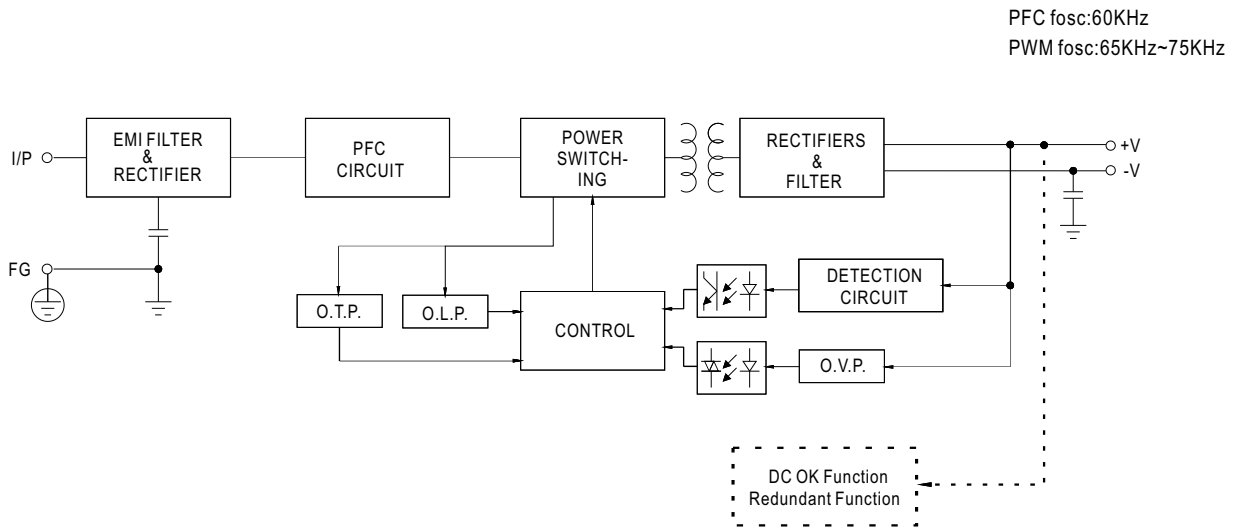

■ **Derating Curve**

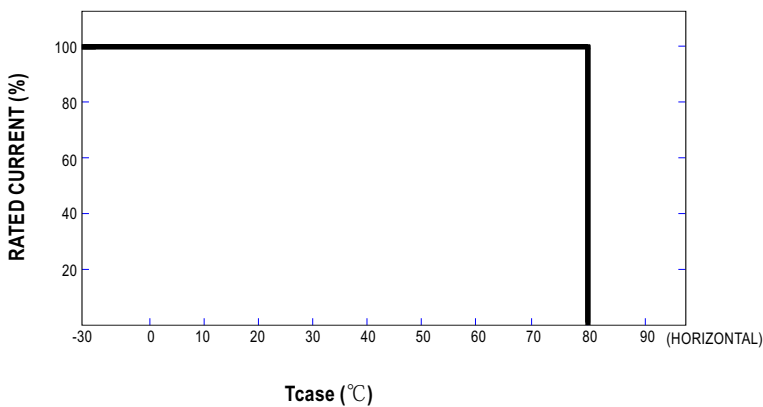
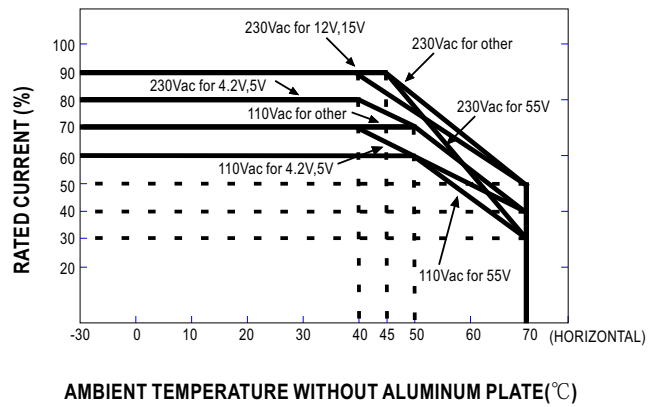
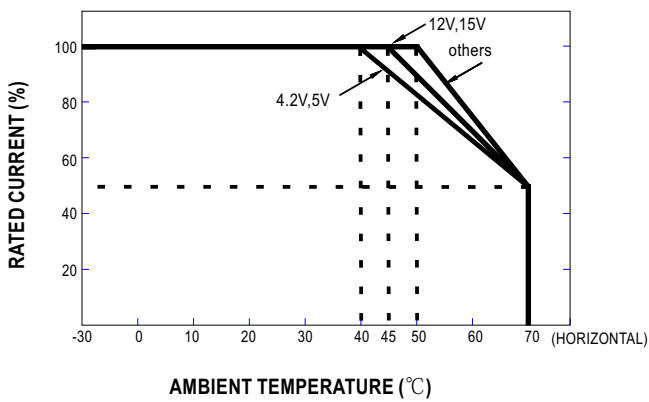



500W Slim Type with PFC Switching Supply

**UHP-500** series

■ **STATIC CHARACTERISTIC**

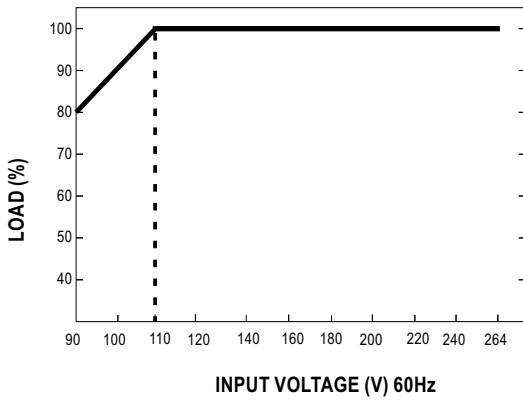

■ **DC OK Relay Contact**

|                      |                         |
|----------------------|-------------------------|
| Contact Close        | PSU turns on/DC ok      |
| Contact Open         | PSU turns off/DC fail   |
| Contact Rating(max.) | 30Vdc/1A resistive load |

■ **Redundant function**

- (1) UHP-500R is built-in redundant function and can be connected 2 units in parallel .
- (2) When in parallel operation the maximum load should not be greater than the rated power of any PSU.

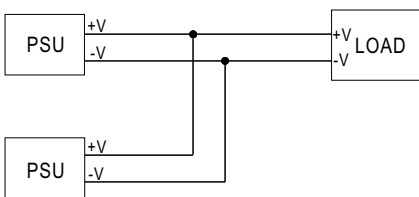



500W Slim Type with PFC Switching Supply

**UHP-500 series**

■ Mechanical Specification

CASE NO.:233D

Unit:mm

Tolerance:±1

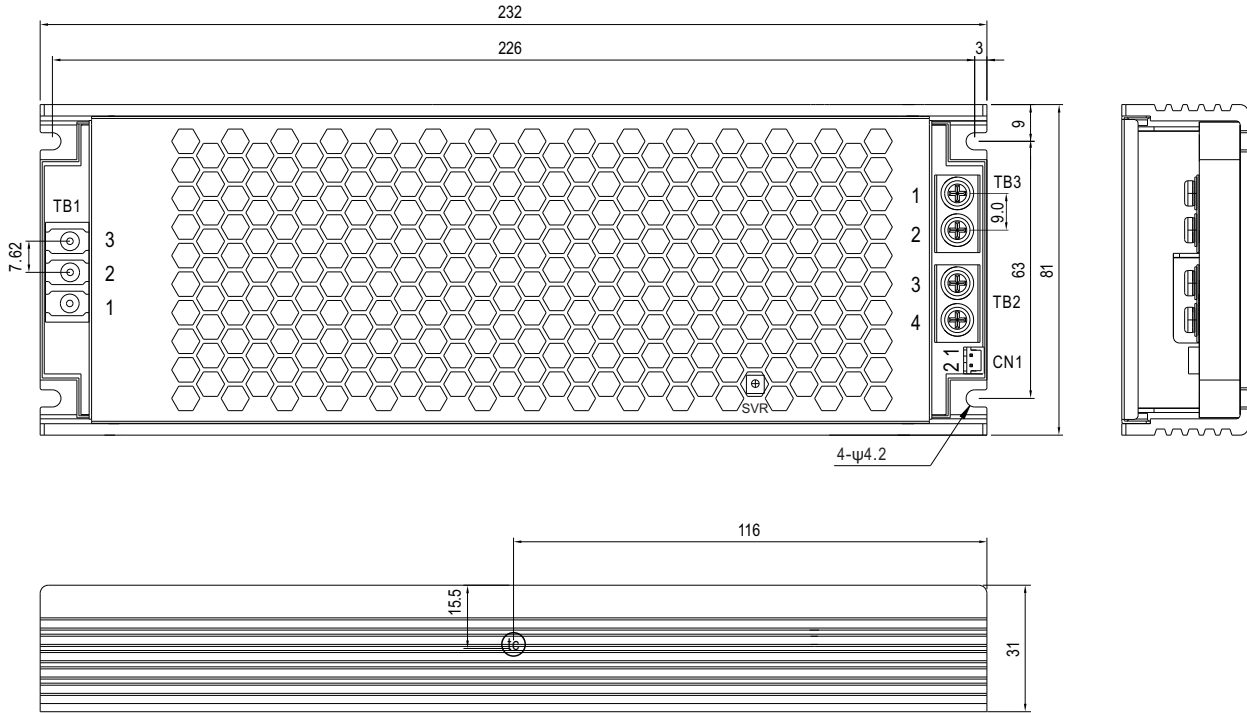

• (tc) : Max. Case Temperature

AC Input Terminal(TB1) pin NO. Assignment

| Pin No. | Assignment | Terminal                | Max mounting torque |
|---------|------------|-------------------------|---------------------|
| 1       | AC/L       | (DEGSON)<br>DG28C-B-03P | 5Kgf-cm             |
| 2       | AC/N       |                         |                     |
| 3       | ⊥          |                         |                     |

DC Output Terminal(TB2, TB3) pin NO. Assignment

| Pin No. | Assignment | Terminal    | Max mounting torque |
|---------|------------|-------------|---------------------|
| 1,2     | -V         | (MW)        | 8Kgf-cm             |
| 3,4     | +V         | MEL-400-02P |                     |

DC OK Connector(CN1):JST B2B-PH-K-S or equivalent

| Pin No. | Assignment | Mating Housing             | Terminal                            |
|---------|------------|----------------------------|-------------------------------------|
| 1       | DC COM1    | JST PHR-2<br>or equivalent | JST SPH-002T-P0.5S<br>or equivalent |
| 2       | DC COM2    |                            |                                     |



500W Slim Type with PFC Switching Supply

**UHP-500** series

### ■ Installation

#### 1. Operate with additional aluminum plate

In order to meet the "Derating Curve" and the "Static Characteristics", UHP-500 series must be installed onto an aluminum plate (or the cabinet of the same size) on the bottom. The size of the suggested aluminum plate is shown as below. And for optimizing thermal performance, the aluminum plate must have an even and smooth surface (or coated with thermal grease), and UHP-500 series must be firmly mounted at the center of the aluminum plate.

unit:mm

