



TR18RDM SERIES 18 WATT AC-DC MEDICAL INTERCHANGEABLE PLUG ADAPTER

Features

- Universal Input Range 80~264Vac
- High Efficiency up to 87%
- Interchangeable AC Plugs
- Leakage Current < 30uA
- Class II
- No Load Power Consumption < 75mW
- Approval IEC/EN/UL 60601-1 2 MOPP
- Approval EN60601-1-11
for Home Healthcare Applications
- Approval EN55011, FCC 47 CFR Part 18 Class B
- Approval IP22
- Design Meets IEC/EN 60335-1
- Operating Altitude 5000m
- Over Voltage Protection
- Continuous Short Circuit Protection
- Meets CoC Tier 2 & DoE Level VI
(Output Cable Length ≤ 1800mm)



AC Plug Sold Separately



MODEL NUMBER	OUTPUT VOLTAGE	OUTPUT CURRENT	VOLTAGE ACCURACY NOTE1	RIPPLE & NOISE NOTE2	LINE REGULATION NOTE3	LOAD REGULATION NOTE4	%EFF. (Typ.) NOTE5
TR18RDM050	5V	3A	±5%	100mV	±1%	±5%	82%
TR18RDM090	9V	2A	±3%	100mV	±1%	±3%	86%
TR18RDM120	12V	1.5A	±3%	120mV	±1%	±2%	86%
TR18RDM150	15V	1.2A	±3%	120mV	±1%	±2%	86%
TR18RDM180	18V	1A	±3%	120mV	±1%	±2%	86%
TR18RDM240	24V	0.75A	±3%	120mV	±1%	±2%	87%

Note:

1. Voltage accuracy is set at 60% full load.
2. Add a 0.1uF ceramic capacitor and a 10uF E.L. capacitor to output for ripple & noise measuring @20MHz BW.
3. Line regulation is measured from 100V_{ac} to 240V_{ac} with 100% full load.
4. Load regulation is measured from 60% to 100% full load and from 60% to 20% full load (60%±40% full load).
5. Typical efficiency at 230 V_{ac} and 75% full load at 25°C.

PART NUMBER

Series	Output Voltage	AC Plug Type	DC Plug Type	Cable Type	Cable Length	Case Color
TR18RDM	XXX	-XXXX	-XX	X	XX	-XX-BK
18W Medical Adapter	050 :5V 090 :9V 120 :12V 150 :15V 180 :18V 240 :24V	Blank: Sold Separately ASUE: Include 4 Type AC Plug	See Page 6	G : UL1571 with OVP	01 : 720mm 02 :1220mm 03 :1800mm 11 :720mm with Ferrite Core 12 :1220mm with Ferrite Core 13 :1800mm with Ferrite Core See page 6 for restrictions	BK-BK: Black-Black BE-BK: Blue-Black

Part Number Example:

TR18RDM120-11G13-BK-BK, 12V_{dc} Output, DC Jack Type, Cable Length 1800mm with Ferrite Core, Case Color Black-Black

TR18RDM120-ASUE-11G03-BE-BK, 12V_{dc} Output, include 4 Type AC Plug, DC Jack Type, Cable Length 1800mm, Case Color Blue-Black



TR18RDM Series

TECHNICAL SPECIFICATIONS

(All specifications are typical at nominal input, full load at 25°C unless otherwise noted.)

ABSOLUTE MAXIMUM RATINGS

PARAMETER	NOTES and CONDITIONS	Device	Min.	Typ.	Max.	Units
Input Voltage		All	80		264	V _{ac}
Operating Temperature	See Derating Curve	All	-30		70	°C
Storage Temperature		All	-30		85	°C
Operating Altitude	IEC/EN/UL 60601-1 Design meets IEC/EN 60335-1	All			5000	m

INPUT CHARACTERISTICS

PARAMETER	NOTES and CONDITIONS	Device	Min.	Typ.	Max.	Units
Operating Voltage Range		All	100		240	V _{ac}
Input Frequency Range		All	47		63	Hz
Maximum Input Current	100% Full load, V _{in} =100V _{ac}	All			0.5	A
Leakage Current		All			30	uA
Inrush Current	V _{in} =240V _{ac} , Cold start at 25°C	All		45		A

OUTPUT CHARACTERISTICS

PARAMETER	NOTES and CONDITIONS	Device	Min.	Typ.	Max.	Units
Output Voltage Set Point	V _{in} =115V _{ac} and 230V _{ac} , I _o =60% Full load T _c =25°C	TR18RDM050	4.75	5	5.25	V _{dc}
		TR18RDM090	8.73	9	9.27	
		TR18RDM120	11.64	12	12.36	
		TR18RDM150	14.55	15	15.45	
		TR18RDM180	17.46	18	18.54	
Operating Output Current Range	V _{in} =115V _{ac} and 230V _{ac} , T _c =25°C	TR18RDM050			3	A
		TR18RDM090			2	
		TR18RDM120			1.5	
		TR18RDM150			1.2	
		TR18RDM180			1	
Operating Output Current Range	V _{in} =115V _{ac} and 230V _{ac} , T _c =25°C	TR18RDM180			1	A
		TR18RDM240			0.75	
Holdup Time	V _{in} =115V _{ac}	All		12		ms
Output Voltage Regulation						
Load Regulation	±40% Full load change	TR18RDM050			±5.0	%
		TR18RDM090			±3.0	
		TR18RDM120			±2.0	
		TR18RDM150			±2.0	
		TR18RDM180			±2.0	
Load Regulation	±40% Full load change	TR18RDM180			±2.0	%
		TR18RDM240			±2.0	
Line Regulation	V _{in} =100V _{ac} to 240V _{ac}	All			±1.0	%
Over Voltage Protection	TVS Component to clamp	TR18RDM050			7.14	V _{dc}
		TR18RDM090			12.60	
		TR18RDM120			15.75	
		TR18RDM150			18.90	
		TR18RDM180			23.1	
Over Voltage Protection	TVS Component to clamp	TR18RDM180			23.1	V _{dc}
		TR18RDM240			31.5	
Over Current Protection	Auto recovery	All	110		180	%
Short Circuit Protection	Auto recovery	All				



TR18RDM Series

PARAMETER	NOTES and CONDITIONS	Device	Min.	Typ.	Max.	Units
Output Ripple and Noise	1. Add a 0.1uF ceramic capacitor and a 10uF aluminum electrolytic capacitor to output 2. Oscilloscope is 20MHz band width 3. Ambient temperature=25°C	TR18RDM050			100	mV
		TR18RDM090			100	
		TR18RDM120			120	
		TR18RDM150			120	
		TR18RDM180			120	
		TR18RDM240			120	
Load Capacitance	1. $V_{in}=115V_{ac}$ and $230V_{ac}$ 2. Output is max. load 3. Ambient temperature=25°C	TR18RDM050			3000	uF
		TR18RDM090			2000	
		TR18RDM120			1500	
		TR18RDM150			1200	
		TR18RDM180			1000	
		TR18RDM240			750	
Efficiency	1. $V_{in}=230V_{ac}$ 2. Output is 75% full load 3. Ambient temperature=25°C	TR18RDM050		82		%
		TR18RDM090		86		
		TR18RDM120		86		
		TR18RDM150		86		
		TR18RDM180		86		
		TR18RDM240		87		

ISOLATION CHARACTERISTICS

PARAMETER	NOTES and CONDITIONS	Device	Min.	Typ.	Max.	Units
Input to Output	1 minute	All			4000	V_{ac}
Isolation Resistance	Input to output	All	100			MΩ

FEATURE CHARACTERISTICS

PARAMETER	NOTES and CONDITIONS	Device	Min.	Typ.	Max.	Units
Switching Frequency	Pout=max. rated power	All		50		kHz

GENERAL SPECIFICATIONS

PARAMETER	NOTES and CONDITIONS	Device	Min.	Typ.	Max.	Units
MTBF	$I_o=100\%$; $T_a=25^\circ C$ per MIL-HDBK-217F	All	750			k hours
Humidity	Non-condensing	All			93	% RH
Shock	Meet MIL-STD-810F Table 516.5, Table 516.5-I 10ms, each axis 3 times($\pm X$ 、 $\pm Y$ 、 $\pm Z$ axis)	All		75		g
Vibration	Meet MIL-STD-810F Table 514.5C-VIII, 15~2000Hz, X、Y、Z axis, 1 hour (each axis),. Total 3 hrs.	All		4		g
Weight		All		115		g
Dimensions		All	3.165x1.693x1.453 Inches (80.40x43.00x36.90mm)			
Safety	Class II, IEC 60601-1:2005+AMD1:2012+AMD2:2020 EN 60601-1:2006+A11:2011+A1:2013+A12:2014+A2:2021 ANSI/AAMI ES60601-1:2005 & A1:2012 & A2:2021 IEC/EN 60601-1-11:2015+AMD1:2020 for Home Healthcare Applications					Ed.3.2
EMC Emission	EN 55011:2016+A11:2020, CISPR 11:2015+AMD1:2016+AMD2:2019, Class B, EN 61000-3-3:2013+A2:2021, FCC 47 CFR Part 18					
Conducted Disturbance	EN 55011:2016+A11:2020, CISPR 11:2015+AMD1:2016+AMD2:2019, FCC 47 CFR Part 18					Class B
Radiated Disturbance	EN 55011:2016+A11:2020, CISPR 11:2015+AMD1:2016+AMD2:2019, FCC 47 CFR Part 18					Class B
Voltage Fluctuations	EN 61000-3-3:2013+A2:2021					
EMC Immunity	EN 60601-1-2:2015+A1:2021, IEC 61000-4-2,3,4,5,6,8,11					Ed.4.1
Electrostatic Discharge (ESD)	IEC 61000-4-2:2008, Air Discharge: $\pm 15kV$ Contact Discharge: $\pm 8kV$					Criteria A
Radio-Frequency, Continuous Radiated Disturbance	IEC 61000-4-3:2020					Criteria A
Electrical Fast Transient (EFT)	IEC 61000-4-4:2012, $\pm 0.5kV$, $\pm 1kV$, $\pm 2kV$					Criteria A



TR18RDM Series

GENERAL SPECIFICATIONS

Surge	IEC 61000-4-5:2014/AMD1:2017, L-N: $\pm 0.5kV$, $\pm 1kV$	Criteria A
Conducted disturbances, induced by RF fields	IEC 61000-4-6:2013	Criteria A
Power frequency magnetic field	IEC 61000-4-8:2009	Criteria A
Voltage dips	IEC 61000-4-11:2020, Dips: 30% Reduction, Dips: >95% Reduction	Criteria A
Voltage interruptions	IEC 61000-4-11:2020, >95% reduction	Criteria A
Application Note Link	TR18RDM Series App Notes	

CHARACTERISTIC CURVE

Power Derating Curve

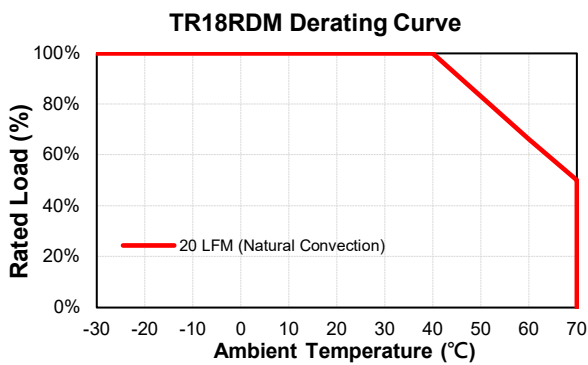

Performance Data

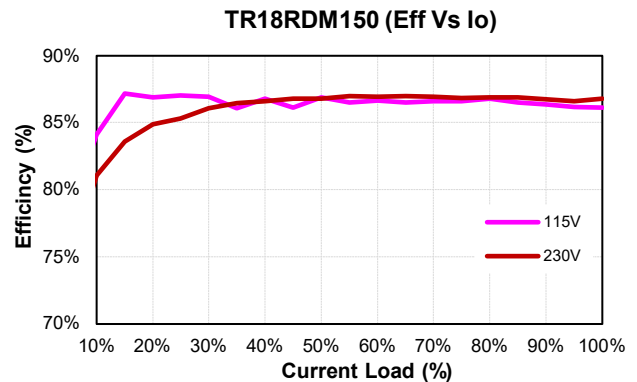
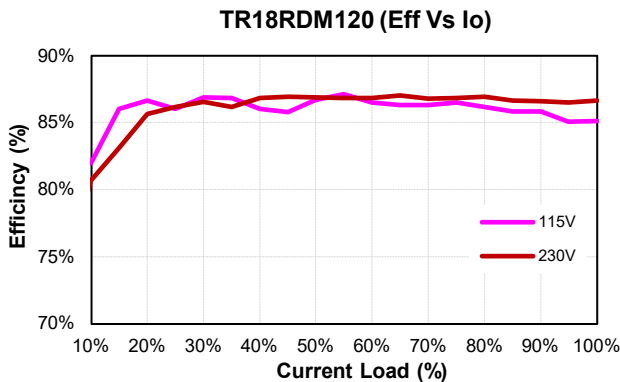
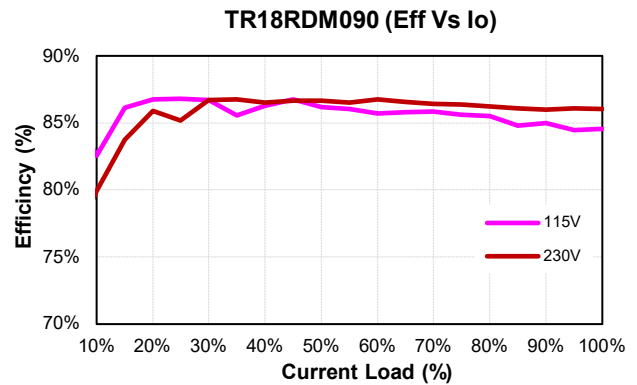
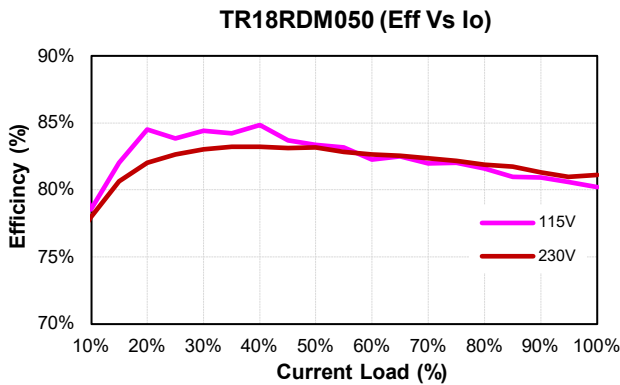



TR18RDM Series

TR18RDM180 (Eff Vs Io)

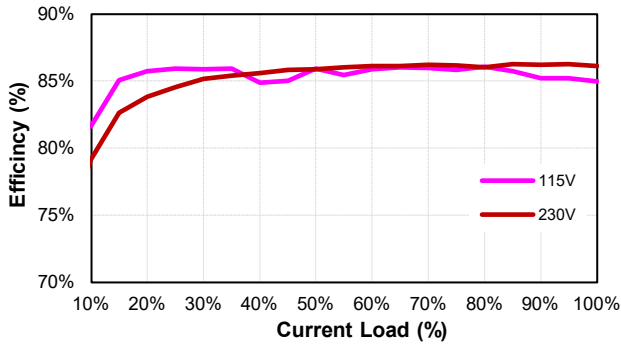

TR18RDM240 (Eff Vs Io)

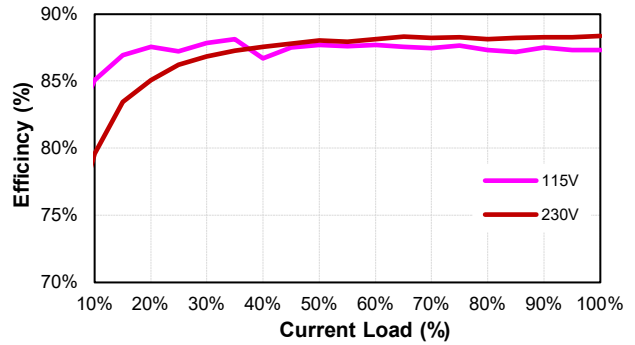



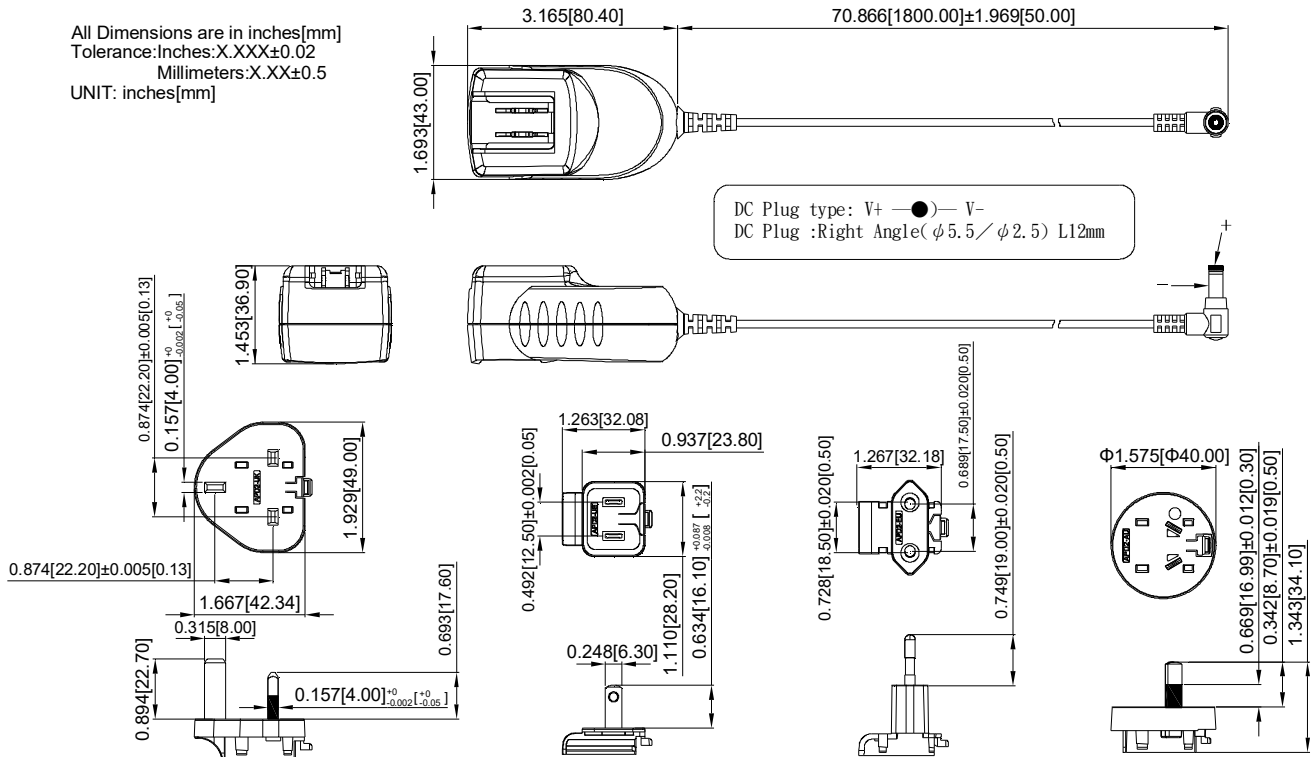

MECHANICAL SPECIFICATION

All Dimensions are in inches[mm]
Tolerance: Inches: X.XXX±0.02
Millimeters: X.XX±0.5
UNIT: inches[mm]

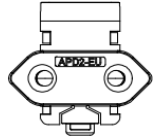

INTERCHANGEABLE AC PLUG SPECIFICALLY for TR18RDM (SOLD SEPARATELY)

TYPE				
	U.K type (U)	American type (A)	European type (E)	Australian type (S)
ORDER NO.	AC PLUG RE-U	AC PLUG RE-A	AC PLUG RE-E	AC PLUG RE-S



TR18RDM Series

STANDARD OUTPUT DC PLUG

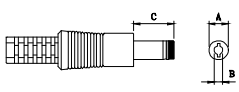
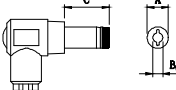
DC Plug Type	Cable Number-XXXXX	A	B	C	Cable Type	Cable Length	Cable AWG
		OD (mm)	ID (mm)	L (mm)			
 <p>Straight/Inner+Outer- + ● - -</p>	11G03	Φ5.5	Φ2.1	12	UL1571	1800mm without Core	18AWG for Vo: 5V, 9V 22AWG for Vo: 12V, 15V, 18V, 24V
	12G03	Φ5.5	Φ2.5	12			
	23G03	Φ5.5	Φ2.1	9.5			
	26G03	Φ5.5	Φ2.5	9.5			
 <p>Right Angle/Inner+Outer- + ● - -</p>	01G03	Φ5.5	Φ2.1	12			
	02G03	Φ5.5	Φ2.5	12			
	21G03	Φ5.5	Φ2.5	9.5			
	24G03	Φ5.5	Φ2.1	9.5			

※Other DC Plug Type please refer to the link: <https://www.cincon.com/productdownload/TR18RDM-cable-DC-plug.pdf>