



LFM200M SERIES 200 WATT MEDICAL AC-DC POWER SUPPLY WITH PFC

Features

- Universal Input Range 85~264Vac
- High Efficiency up to 94%
- Class I
- 25.4mm Low Profile Package
- No Load Input Power Consumption<0.3W
- 48V, 54V No Load Input Power Consumption<0.4W
- Approval Safety IEC/EN/UL 60601-1 2 MOPP
- Approval Safety IEC/EN/UL 62368-1
- Meets IEC/EN 60335-1
- Operating Altitude 5000m
- Continuous Short Circuit Protection
- Over Voltage Protection
- Over Temperature Protection
- High Power Density 28.35W/Inches³
- Active PFC Function



MODEL NUMBER	OUTPUT VOLTAGE	OUTPUT CURRENT			RIPPLE & NOISE NOTE1	VOLTAGE ACCURACY NOTE2	LINE REGULATION NOTE3	LOAD REGULATION NOTE4	%EFF. (Typ.) NOTE5
		With Fan NOTE6	Without Conduction Cooling	With Conduction Cooling NOTE7					
LFM200M120C	12 V	16.67 A	9.17 A	14.17 A	150 mV	±1%	±0.2%	±0.5%	92%
LFM200M150C	15 V	13.34 A	7.33 A	11.33 A	150 mV	±1%	±0.2%	±0.5%	92%
LFM200M240C	24 V	8.34 A	4.58 A	7.08 A	200 mV	±1%	±0.2%	±0.5%	94%
LFM200M280C	28 V	7.14 A	3.93 A	6.07 A	200 mV	±1%	±0.2%	±0.5%	93%
LFM200M300C	30 V	6.67 A	3.67 A	5.67 A	200 mV	±1%	±0.2%	±0.5%	93%
LFM200M360C	36 V	5.56 A	3.06 A	4.72 A	200 mV	±1%	±0.2%	±0.5%	94%
LFM200M480C	48 V	4.17 A	2.29 A	3.54 A	200 mV	±1%	±0.2%	±0.5%	94%
LFM200M540C	54 V	3.7 A	2.04 A	3.15 A	200 mV	±1%	±0.2%	±0.5%	93%

Note:

1. Add a 0.1uF ceramic capacitor and a 10uF E.L. capacitor to output for ripple & noise measuring @20MHz BW.
2. Voltage accuracy is set at full load.
3. Line regulation is measured from 100Vac to 240Vac with full load.
4. Load regulation is measured from 10% to 100% full load.
5. Typical efficiency at 230 Vac and full load at 25°C.
6. Forced air convection with 14CFM above 110Vac.
7. With addition cooling conduction plate, 17.78 by 17.78 cm with min. 0.2 cm thick, as below

PART NUMBER

Series	Number of Outputs	Nominal Output Voltage	Type	Mounting Inserts
LFM200	O	XXX	X	-YZ
LFM200	M : Medical	120 : 12V 150 : 15V 240 : 24V 280 : 28V 300 : 30V 360 : 36V 480 : 48V 540 : 54V	C : With Cover	Blank: Through Hole C0: Threaded Hole

Part Number Example: **LFM200M120C-C0**: With Cover 200W, Medical 12Vdc Output, Threaded Hole



LFM200M Series

TECHNICAL SPECIFICATIONS

(All specifications are typical at nominal input, full load at 25°C unless otherwise noted.)

ABSOLUTE MAXIMUM RATINGS

PARAMETER	NOTES and CONDITIONS	Device	Min.	Typ.	Max.	Units
Input Voltage	Safety approvals only to the AC input	All	85		264	V _{ac}
Input Voltage		All	115		370	V _{dc}
Operating Temperature	See Derating Curve	All	-40		80	°C
Operating Case Temperature	At the Center of Base Plate (T _c = Case temperature)	All	-40		90	°C
Storage Temperature		All	-40		85	°C
Operating Altitude		All			5000	m

INPUT CHARACTERISTICS

PARAMETER	NOTES and CONDITIONS	Device	Min.	Typ.	Max.	Units
Operating Voltage Range		All	100		240	V _{ac}
Input Frequency Range		All	47		63	Hz
Maximum Input Current	100% Load, V _{in} =100V _{ac}	All			3.15	A
Leakage Current	Contact leakage current Earth leakage current	All			100 300	uA
Inrush Current	V _{in} =240V _{ac} , Cold Start @25°C	All			85	A
Power Factor	230V _{ac} @ Full load	All	0.96	0.98		

OUTPUT CHARACTERISTICS

PARAMETER	NOTES and CONDITIONS	Device	Min.	Typ.	Max.	Units
Output Voltage Set Point	V _{in} =Nominal V _{in} , I _o =I _o max., T _c =25°C	LFM200M120C	11.88	12	12.12	V _{dc}
		LFM200M150C	14.85	15	15.15	
		LFM200M240C	23.76	24	24.24	
		LFM200M280C	27.72	28	28.28	
		LFM200M300C	29.7	30	30.3	
		LFM200M360C	35.28	36	36.72	
		LFM200M480C	47.52	48	48.48	
Operating Output Current Range	V _{in} =85V _{ac} ~264V _{ac} , See Derating Curve	LFM200M120C	0		16.67	A
		LFM200M150C	0		13.34	
		LFM200M240C	0		8.34	
		LFM200M280C	0		7.14	
		LFM200M300C	0		6.67	
		LFM200M360C	0		5.56	
		LFM200M480C	0		4.17	
LFM200M540C	0		3.7			
Holdup Time	V _{in} =115V _{ac}	All	10	12		ms
Output Voltage Regulation						
Load Regulation	10% Load to full load	All			±0.5	%
Line Regulation	V _{in} =High line to low line	All			±0.2	%
Output Voltage Adjustment	P _o ≤ max rated power, I _o ≤ I _o max	All	-5		+5	%
Over Voltage Protection	Latch Off (AC recycle to reset)	LFM200M120C			16	V _{dc}
		LFM200M150C			20	
		LFM200M240C			32	
		LFM200M280C			35	
		LFM200M300C			35	
		LFM200M360C			45	
		LFM200M480C			55	
LFM200M540C			63			



LFM200M Series

PARAMETER	NOTES and CONDITIONS	Device	Min.	Typ.	Max.	Units
Over Current Protection	Auto recovery (Output is rated load)	All	125	145	165	%
Short Circuit Protection	Auto recovery	All				
Over Temperature Protection	Auto recovery	All				
Output Ripple and Noise	1. Add a 0.1uF ceramic capacitor and a 10uF aluminum electrolytic capacitor to output 2. Oscilloscope is 20MHz band width. 3. Ambient Temperature=25°C	LFM200M120C LFM200M150C LFM200M240C LFM200M280C LFM200M300C LFM200M360C LFM200M480C LFM200M540C			150 150 200 200 200 200 200 200	mV
Load Capacitance	1. $V_{in}=115V_{ac}$ and $230V_{ac}$ 2. Output is max. Load 3. Ambient temperature=25°C	LFM200M120C LFM200M150C LFM200M240C LFM200M280C LFM200M300C LFM200M360C LFM200M480C LFM200M540C			6800 5440 3440 3440 3220 2680 2000 1560	uF
Efficiency	1. Input Voltage is 230Vac 2. Output is rated load 3. Ambient temperature=25°C	LFM200M120C LFM200M150C LFM200M240C LFM200M280C LFM200M300C LFM200M360C LFM200M480C LFM200M540C		92 92 94 93 93 94 94 93		%

ISOLATION CHARACTERISTICS

PARAMETER	NOTES and CONDITIONS	Device	Min.	Typ.	Max.	Units
Input to Output	1 Minute (without dielectric breakdown)	All			4250	V_{ac}
Input to Earth (Ground)	1 Minute (without dielectric breakdown)	All			2000	V_{ac}
Output to Earth (Ground)	1 Minute (without dielectric breakdown)	All			2000	V_{ac}
Isolation Resistance	Input to output	All	100			MΩ

FEATURE CHARACTERISTICS

PARAMETER	NOTES and CONDITIONS	Device	Min.	Typ.	Max.	Units
Switching Frequency		15V		130		kHz
		Others		110		

GENERAL SPECIFICATIONS

PARAMETER	NOTES and CONDITIONS	Device	Min.	Typ.	Max.	Units
MTBF	$I_o=100\%$; $T_a=25^\circ\text{C}$ per MIL-HDBK-217F	All	450			k hours
Life Time	@75% Load, 40°C	All	26			k hours
Humidity	Non-condensing	All			93	% RH
Shock	Meet MIL-STD-810F Table 516.5, Table 516.5-I 10ms, each axis 3 times($\pm X$ 、 $\pm Y$ 、 $\pm Z$ axis)	All		75		g
Vibration	Meet MIL-STD-810F Table 514.5C-VIII, 15~2000Hz, X、Y、Z axis, 1 hour (each axis),. Total 3 hrs.	All		4		g



LFM200M Series

PARAMETER	NOTES and CONDITIONS	Device	Min.	Typ.	Max.	Units
Weight		All		220		grams
Dimensions		All	3.09x2.28x1.0 Inches (78.6x57.9x25.4 mm)			
Safety	Class I, ANSI/AAMI ES 60601-1:2005 & A1:2012 & A2:2021 IEC 60601-1:2005/AMD1:2012 + AMD2:2020 EN 60601-1:2006/A1:2013 + A12:2014 + A2:2021					Ed. 3.2
	Class I, IEC/EN/UL 62368-1					Ed. 3.0
EMC Emission	EN 55011: 2016+A2: 2021, Class B, IEC/EN 61000-3-2: 2019+A1:2021, EN 61000-3-3: 2013+A2: 2021, 47 CFR FCC Part 18					
	EN 55032:2015+A11:2020, EN 61000-6-4:2019, EN 61204-3:2018, EN 61000-3-2:2019+A1:2021, EN 61000-3-3:2013+A2:2021, 47 CFR FCC Part 15					
Conducted Disturbance	EN 55011: 2016+A2: 2021, EN 55032:2015+A11:2020 47, CFR FCC Part 18 & Part 15					Class B
Radiated Disturbance	EN 55011: 2016+A2: 2021, EN 55032:2015+A11:2020 47, CFR FCC Part 18 & Part 15					Class B
Harmonic Current Emissions	IEC/EN 61000-3-2: 2019+A1:2021					Class A, C, D
Voltage Fluctuations & Flicker	EN 61000-3-3:2013+A2: 2021					Criterion A
EMC Immunity	EN 60601-1-2: 2015+A1:2021, IEC/EN 61000-4-2, 3, 4, 5, 6, 8, 11					Ed 4.1
	EN 55035:2017+A11:2020, EN 61000-6-2:2019, EN 61204-3:2018					
Electrostatic Discharge (ESD)	IEC 61000-4-2:2009 Air Discharge: ±15kV, Contact Discharge: ±8kV					Criterion A
Radio-Frequency, Continuous Radiated Disturbance	IEC/EN 61000-4-3: 2020					Criterion A
Electrical Fast Transient (EFT)	EN 61000-4-4:2012, ±2kV					Criterion A
Surge	EN 61000-4-5:2014+A1:2017, L-N: ±2kV, L-E (Ground): ±4kV					Criterion A
Conducted Disturbances, Induced by RF Fields	EN 61000-4-6: 2014+AC: 2015					Criterion A
Power Frequency Magnetic Field	EN 61000-4-8: 2010					Criterion A
Voltage Dips	IEC/EN 61000-4-11: 2020, Dip: 30% Reduction, Dip >95% Reduction					Criterion A
Voltage Interruptions	IEC/EN 61000-4-11: 2020, >95% reduction					Criterion B
Application Note Link						LFM200M Series App Notes

CHARACTERISTIC CURVE

Power Derating Curve

Output Power vs Ambient Temperature

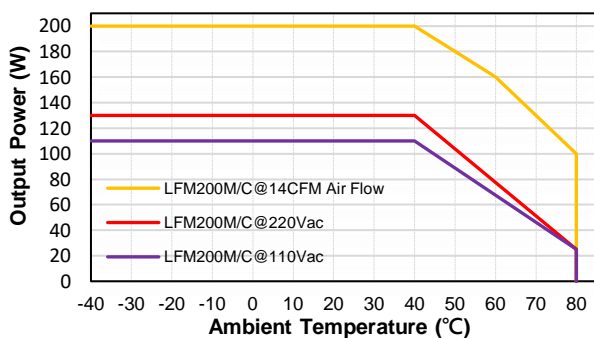

Output Power & Input Voltage

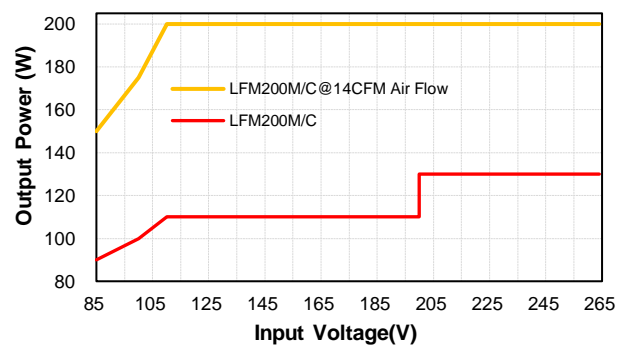



LFM200M Series

Conduction Convection with External Baseplate (17.78cmx17.78cmx0.2cm)

Output Power vs Ambient Temperature

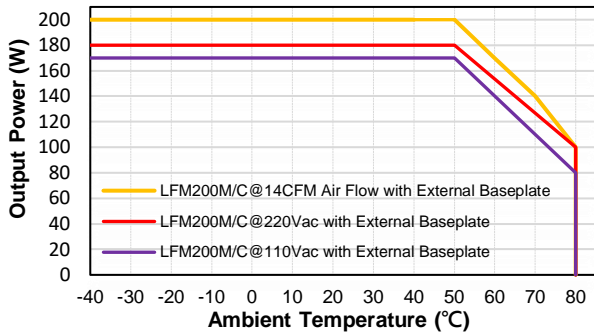

Output Power vs Case Temperature (Tc)

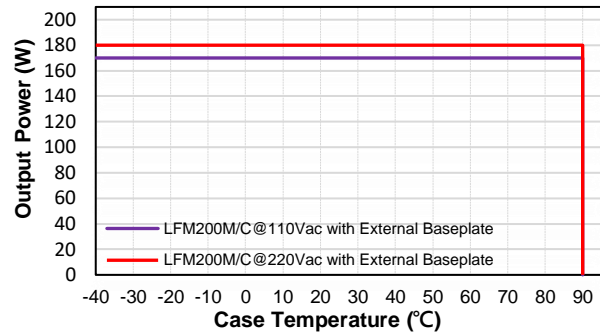

Output Power & Input Voltage

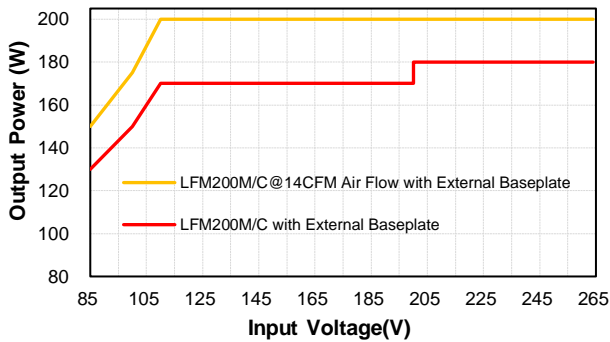

Performance Data

LFM200M120 (Eff Vs Io)

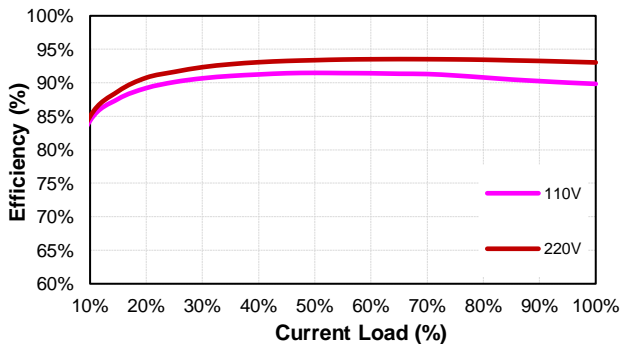

LFM200M150 (Eff Vs Io)

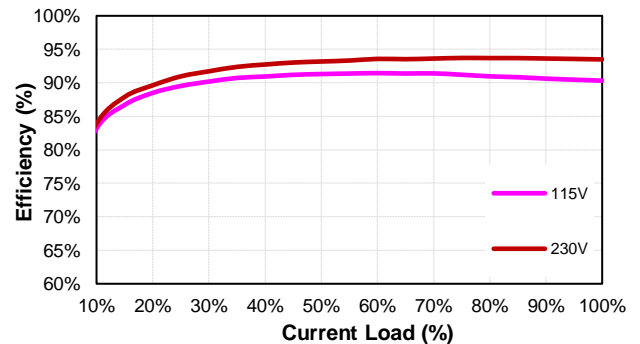

LFM200M240 (Eff Vs Io)

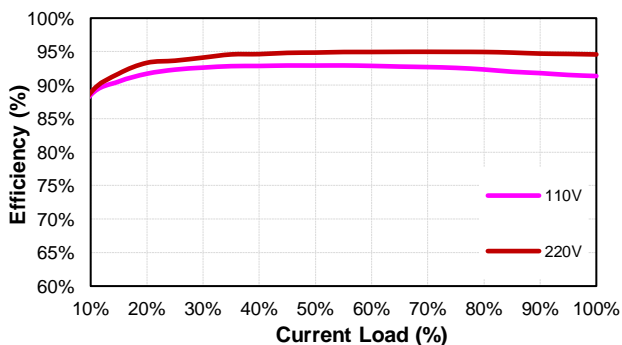

LFM200M280 (Eff Vs Io)

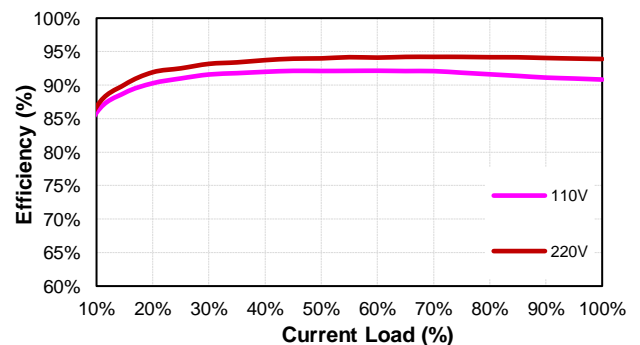



LFM200M Series

LFM200M300 (Eff Vs Io)

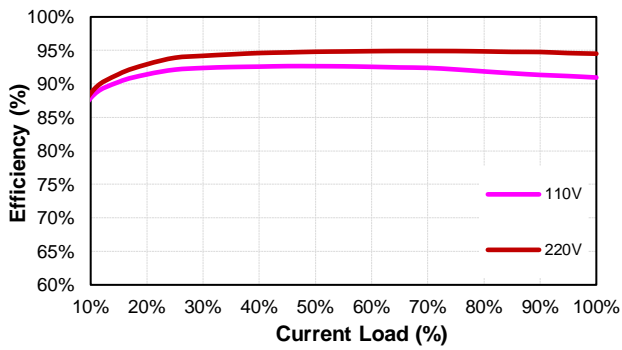

LFM200M360 (Eff Vs Io)

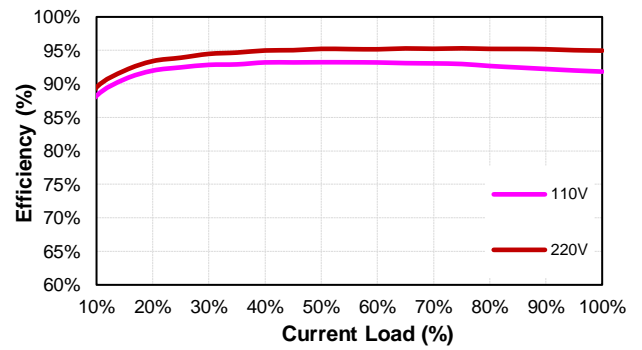

LFM200M480 (Eff Vs Io)

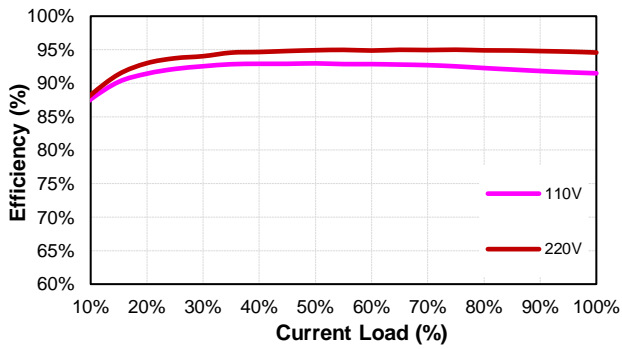

LFM200M540 (Eff Vs Io)

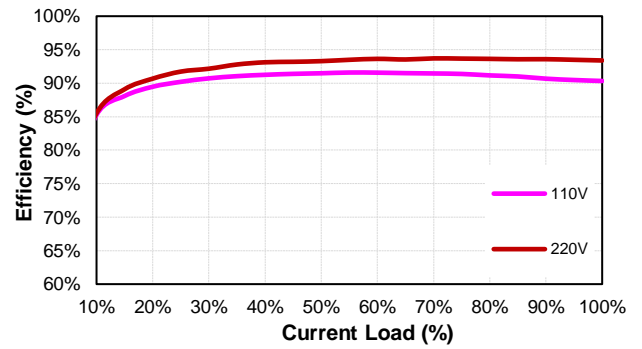



LFM200M Series

MECHANICAL SPECIFICATION

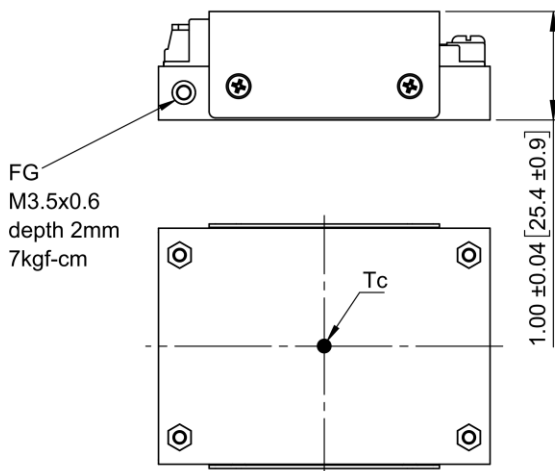
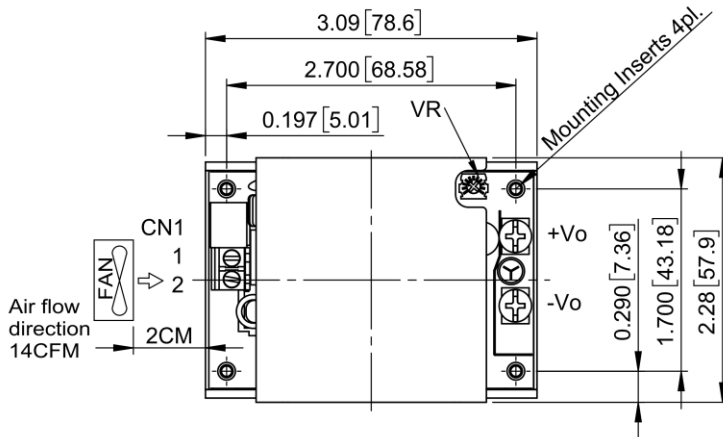

All Dimensions in Inches[mm]

Tolerance Inches: x.xx=±0.03, x.xxx=±0.020

Millimeters: x.x=±0.7, x.xx=±0.50

AC Input Connector(CN1):ECE ETB22

Pin	Function	Mating Wire Range
1	ACL	14~18 AWG
2	ACN	

DC Output Connector:KANG YANG PCB-58M4

Function	The screw locked torque
+Vo	M4 7kgf-cm
-Vo	

Mounting Inserts

Series	Option
Blank	∅3.2 Through depth 10.5mm
-C0	M3x0.5 Threaded depth 10.5mm