

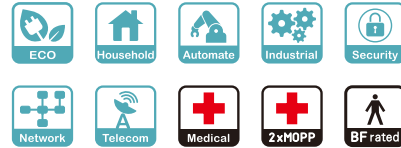

(NGE18I)

(NGE18E)

(NGE18U)



Features

- MEAN WELL Patent Application Number: 202330347779.4
- Interchangeable AC plugs (I-Type)
- Global certificates in multi-fields
(ITE 62368-1, Medical 60601-1, Household 60335-1, Industrial 61558-1/-2-16)
- 80~264Vac Universal AC input
- Ultra slim(28mm)
- No load power consumption < 0.075W
- Energy efficiency Level VI
- Class II power (no earth pin)
- Protections: Short circuit / Overload / Over voltage
- Pass LPS
- Extremely low leakage current < 100uA
- -30°C~+70°C wide range working temperature
- Various DC plug quick adapter accessory available
(Plug kit sold sperately, please refer to : https://www.meanwell.com/upload/pdf/DC_plug.pdf)
- 3 years warranty

Applications

- Consumer electronic devices
- Telecommunication devices
- Office facilities
- Industrial equipments
- Medical devices
- Household devices

GTIN CODE

MW Search: <https://www.meanwell.com/serviceGTIN.aspx>

Description

NGE18 is a highly reliable, 18W wall-mounted style single-output green adaptor series, which is compact and convenient for carry. This product is equipped with 5 types of interchangeable AC plug (European, USA, U.K., Australian and China type) that makes it very suitable for travel use. NGE18 is a Class II power unit (no FG), accepting the input range from 80VAC to 264VAC that it can satisfy the demands for various types of electrical devices.

With the working efficiency up to 88% and the extremely low no-load power consumption below 0.075W, NGE18 is compliant with the latest USA energy regulation EISA 2007/DoE, Canada NRCAN, Australia and New Zealand MEPS, EU ErP and CoC version 5. The supreme feature allows the adaptor to save the energy when it is under either the operating mode or the standby mode. The entire series is approved for ITE, medical household and industrial appliance safety regulations; moreover, it adopts the 94V-0 flame retardant plastic case that it can effectively prevent users from electric hazard.

Model Encoding

NGE 18 I 12 -P1J

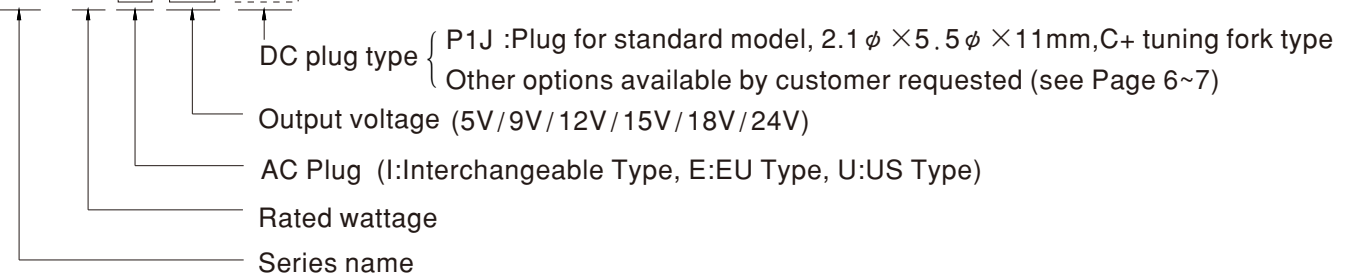



18W AC-DC Reliable Wall-mounted Interchangeable Type Green Adaptor **NGE18** series











SPECIFICATION

ORDER NO.		NGE18○05-P1J	NGE18○09-P1J	NGE18○12-P1J	NGE18○15-P1J	NGE18○18-P1J	NGE18○24-P1J	
		○ = I, U, E						
OUTPUT	DC VOLTAGE <small>Note.2</small>	5V	9V	12V	15V	18V	24V	
	RATED CURRENT	3A	2A	1.5A	1.2A	1A	0.75A	
	CURRENT RANGE	0 ~ 3A	0 ~ 2A	0 ~ 1.5A	0 ~ 1.2A	0 ~ 1A	0 ~ 0.75A	
	RATED POWER	15W	18W	18W	18W	18W	18W	
	RIPPLE & NOISE (max.) <small>Note.3</small>	60mVp-p	100mVp-p	120mVp-p	150mVp-p	180mVp-p	240mVp-p	
	VOLTAGE TOLERANCE <small>Note.4</small>	±5.0%	±5.0%	±3.0%	±3.0%	±3.0%	±3.0%	
	LINE REGULATION <small>Note.5</small>	±1.0%	±1.0%	±1.0%	±1.0%	±1.0%	±1.0%	
	LOAD REGULATION <small>Note.6</small>	±5.0%	±5.0%	±3.0%	±3.0%	±3.0%	±3.0%	
SETUP, RISE, HOLD UP TIME	1500ms, 30ms, 30ms / 230VAC 3000ms, 30ms, 10ms / 115VAC at full load							
INPUT	VOLTAGE RANGE <small>Note.7</small>	80 ~ 264VAC 113 ~ 370VDC						
	FREQUENCY RANGE	47 ~ 63Hz						
	EFFICIENCY (Typ.)	82%	87.5%	87%	87%	88%	88%	
	AC CURRENT	0.4A / 115VAC 0.25A / 230VAC						
	INRUSH CURRENT (max.)	COLD START 40A / 115VAC 80A / 230VAC						
	LEAKAGE CURRENT (max.)	Touch current < 100uA (rms) @264VAC						
PROTECTION	OVERLOAD	110% ~ 150% rated output power Protection type : Hiccup mode, recovers automatically after fault condition is removed						
	OVER VOLTAGE	115% ~ 140% rated output voltage Protection type : Clamp by zener diode						
ENVIRONMENT	WORKING TEMP.	-30 ~ +70°C (Refer to "Derating Curve")						
	WORKING HUMIDITY	20% ~ 90% RH non-condensing						
	STORAGE TEMP., HUMIDITY	-20 ~ +85°C, 10 ~ 95% RH non-condensing						
	TEMP. COEFFICIENT	±0.03% / °C (0 ~ 45°C)						
	VIBRATION	10 ~ 500Hz, 2G 10min./1cycle, period for 60min. each along X, Y, Z axes						
SAFETY & EMC <small>(Note. 8)</small>	SAFETY STANDARDS	CB IEC62368-1, IEC60601-1/-1-11, IEC61558-1/-2-16, IEC60335-1; UL UL62368-1, CSA C22.2 NO. 62368-1, ANSI/AAMI ES60601-1/-1-11(3.2 Version), CAN/CSA-C22.2 NO.60601-1/-1-11; ANSI/AAMI ES60601-1-11, CAN/CSA-C22.2 NO.60601-1-11(for U Type only) DEKRA BS EN/EN62368-1, BS EN/EN60601-1/-1-11, BS EN/EN61558-1/-2-16, BS EN/EN60335-1; PSE J62368-1; BSMI CNS15598-1; RCM AS/NZS 61558-1/-2-16; EAC TPTC004; CCC GB4943.1 approved. (Please refer to next page for more details)						
	WITHSTAND VOLTAGE	I/P-O/P:4000VAC						
	ISOLATION RESISTANCE	I/P-O/P:100M Ohms / 500VDC / 25°C / 70% RH						
	EMC EMISSION	Parameter	Standard				Test Level / Note	
		Conducted emission	BS EN/EN55032(CISPR32)/EN55011, FCC Part15, CNS15936, GB/T 9254.1-2021				Class B	
		Radiated emission	BS EN/EN55032(CISPR32)/EN55011, FCC Part15, CNS15936, GB/T 9254.1-2021				Class B	
	EMC IMMUNITY	Parameter	Standard				Test Level /Note	
		ESD	BS EN/EN61000-4-2				Level 3, 15KV air; Level 2, 8KV contact	
		RF field susceptibility	BS EN/EN61000-4-3				Level 2, 3V/m	
		EFT bursts	BS EN/EN61000-4-4				Level 3, 2KV	
Surge susceptibility		BS EN/EN61000-4-5				Level 3, 1KV/L-N		
Conducted susceptibility		BS EN/EN61000-4-6				Level 2, 3V		
Magnetic field immunity		BS EN/EN61000-4-8				Level 1, 1A/m		
Voltage dips, interruption	BS EN/EN61000-4-11				>95% dip 0.5 periods, 30% dip 25 periods, >95% interruptions 250 periods			
OTHERS	MTBF	1272.8 Khrs min. MIL-HDBK-217F (25°C)		7192.4 Khrs min. Telcordia TR/SR-332(Bellcore) (25°C)				
	DIMENSION	48*28*55mm (L*W*H)						
	PACKING	MAIN BODY	112g; 96pcs/ 12.6Kg / 1.02CUFT for NGE18lxx/Uxx-P1J			127g; 72pcs/ 11.2Kg / 1.36CUFT for NGE18Exx-P1J		
AC PLUGS		Refer to Page 3						
DC OUTPUT CONNECTOR	PLUG	See page 6~7 ; Other type available by customer requested						
	CABLE	See page 6~7 ; Other type available by customer requested						
NOTE	<p>1.All parameters are specified at 230VAC input, rated load, 25°C 70% RH ambient.</p> <p>2.DC voltage: The output voltage set at point measure by plug terminal & 50% load.</p> <p>3.Ripple & noise are measured at 20MHz by using a 12" twisted pair terminated with a 0.1 μF & 47 μF capacitor.</p> <p>4.Tolerance: includes set up tolerance, line regulation, load regulation.</p> <p>5.Line regulation is measured from low line to high line at rated load.</p> <p>6.Load regulation is measured from 0% to 100% rated load</p> <p>7.Derating may be needed under low input voltage. Please check the derating curve for more details.</p> <p>8.The power supply is considered as an independent unit, but the final equipment still need to re-confirm that the whole system complies with the EMC directives. For guidance on how to perform these EMC tests, please refer to "EMI testing of component power supplies." (as available on https://www.meanwell.com/Upload/PDF/EMI_statement_en.pdf)</p> <p>9.Design meet US DoE Level VII (from Docket number EERE-2020-BT-STD-0006).</p> <p>※ Product Liability Disclaimer : For detailed information, please refer to https://www.meanwell.com/serviceDisclaimer.aspx</p>							









18W AC-DC Reliable Wall-mounted Interchangeable Type Green Adaptor **NGE18 series**

■ Interchangeable AC Plug Specifically for NGE12/18/30/45/65/90 (I-Type)



Order NO.	NGE18Ixx-P1J 					NGE18Exx-P1J 	NGE18Uxx-P1J 
AC plug	Interchangeable Type					Non-Interchangeable Type	
	EU 	US 	UK 	AU 	CN 		
Certificate							

■ AC Plugs Accessory (Sold Separately)

MW's order NO.	Per Unit 	Per Bag	Per Carton	
		Q'Ty	Q'Ty	G.W.
AC PLUG-EU4		30 pcs	300 pcs (10 bags)	5.6Kg
AC PLUG-US4		30 pcs	300 pcs (10 bags)	5.3Kg
AC PLUG-UK4		30 pcs	300 pcs (10 bags)	7.1Kg
AC PLUG-AU4		30 pcs	300 pcs (10 bags)	5.3Kg
AC PLUG-CN4		30 pcs	300 pcs (10 bags)	5.3Kg
AC PLUG-MIX4	 (Per Set)	30 pcs (5 Types*6 mixed bags)	300 pcs (5 Types*6 mixed bags) (10 bags)	5.78Kg



■ Interchangeable AC Plug Installation Steps (Convertible with I Type only)

Step1	Step2
	
<p>Slide in AC converter along the guided rail between the metal prongs until it is locked in (with a “click” sound).</p>	<p>Check if the new plug type is stable and correct before use.</p>

Note:

1. NGE18I main body unit and AC inlet plug should be ordered separately.
2. NGE18I needs to be used along with one of the AC inlet plug (EU,US,UK,AU,CN).

■ Derating Curve

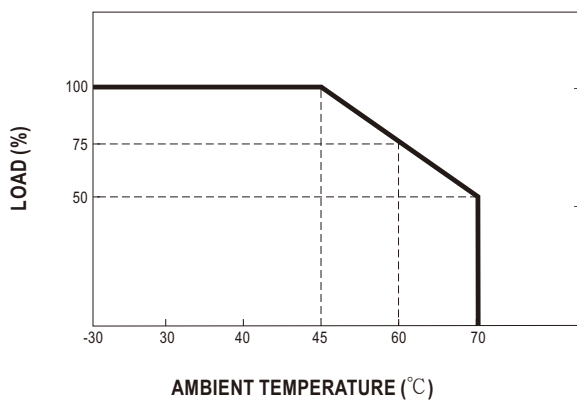

■ Static Characteristics

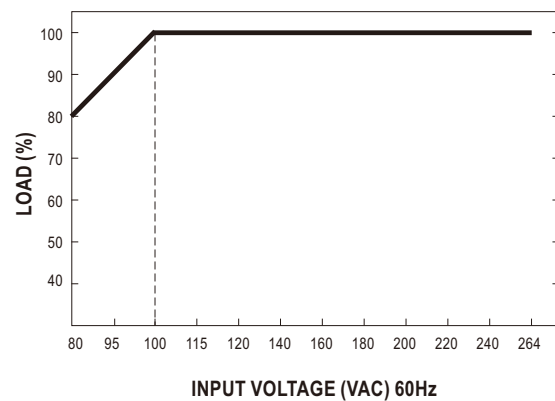



18W AC-DC Reliable Wall-mounted Interchangeable Type Green Adaptor **NGE18** series

■ Mechanical Specification

※ Cable connection

Unit:mm

NGE18Ixx-P1J:

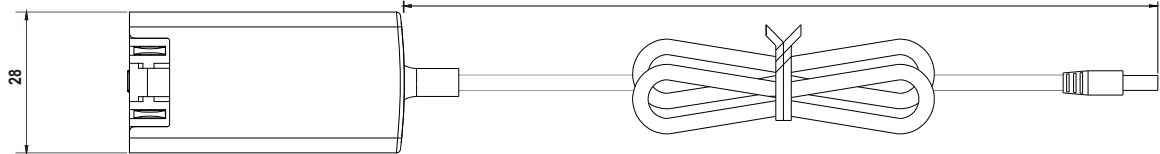
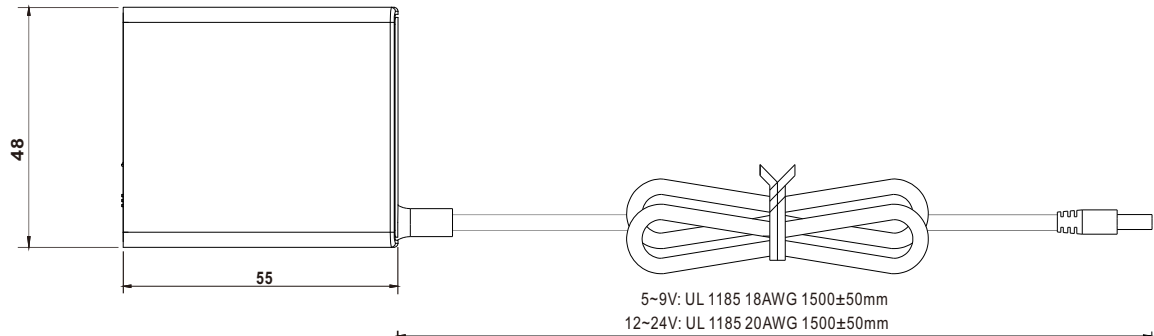

NGE18Exx-P1J:

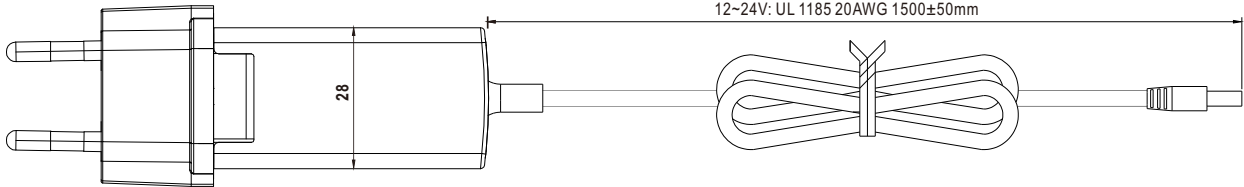
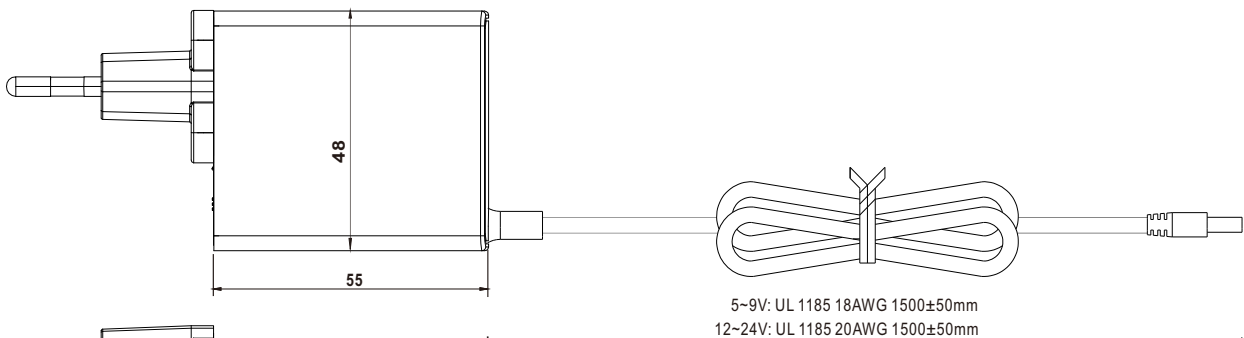

NGE18Uxx-P1J:

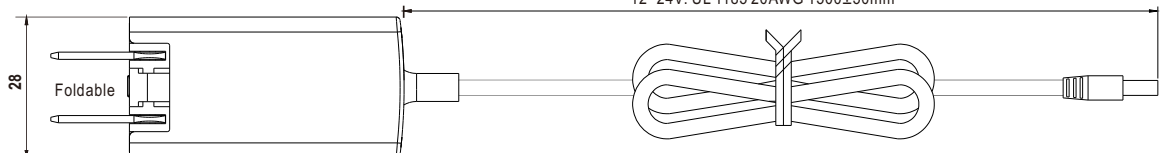
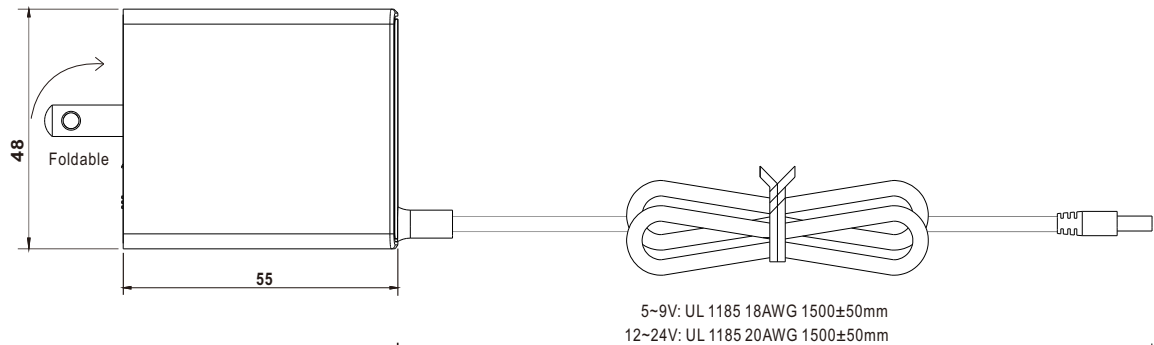



■ DC Output Plug

◎ Standard plug: P1J

Unit:mm

P1J	Pin Assignment
	Outside Inside

◎ DC plug changeable through:

- (1) Customization of the standard part with an optional DC plug according to the table (MOQ applicable)
- (2) Quick adapter accessory (sold separately without MOQ)

Please refer to below table and online selection guide : https://www.meanwell.com/upload/pdf/DC_plug.pdf

Example quick adapter accessory:





◎ Optional DC plug: (Available in customized cable or quick adapter)

Tuning Fork Style	Type No.	A	B	C	Quick Adapter Accessory
		OD	ID	L	
	P1I (Straight)	5.5	2.1	9.5	Available (Current rating: 7.5A max.)
	P1L (Straight)	5.5	2.5	9.5	
	P1M (Straight)	5.5	2.5	11.0	
	P1IR (Right-angled)	5.5	2.1	9.5	
	P1JR (Right-angled)	5.5	2.1	11.0	
	P1LR (Right-angled)	5.5	2.5	9.5	
	P1MR (Right-angled)	5.5	2.5	11.0	
Barrel Style	Type No.	A	B	C	None
		OD	ID	L	
	P2I (Straight)	5.5	2.1	9.5	
	P2J (Straight)	5.5	2.1	11.0	
	P2L (Straight)	5.5	2.5	9.5	
	P2M (Straight)	5.5	2.5	11.0	
	P2IR (Right-angled)	5.5	2.1	9.5	
	P2JR (Right-angled)	5.5	2.1	11.0	
	P2LR (Right-angled)	5.5	2.5	9.5	
P2MR (Right-angled)	5.5	2.5	11.0		
Lock Style	Type No.	A	B	C	None
		OD	ID	L	
	P2S(S761K)	5.53	2.03	12.06	
	P2K(761K)	5.53	2.54	12.06	
	P2C(S760K)	5.53	2.03	9.52	
	P2D(760K)	5.53	2.54	9.52	

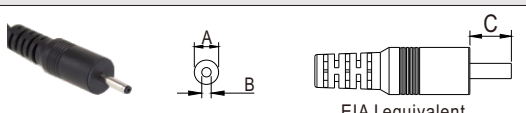
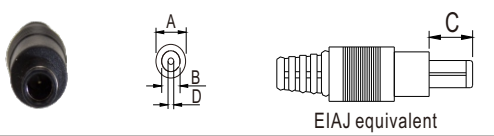
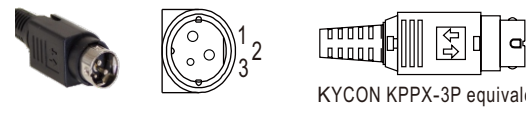

18W AC-DC Reliable Wall-mounted Interchangeable Type Green Adaptor **NGE18 series**

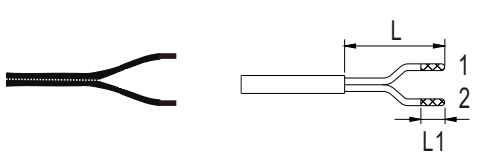
Min. Pin Style	Type No.	A	B	C	Quick Adapter Accessory	
		OD	ID	L		
 <p>EIAJ equivalent</p>	P3A	2.35	0.7	11.0	Available (Current rating: 5A max.)	
	P3B	4.0	1.7	11.0		
	P3C	4.75	1.7	11.0		
Center Pin Style	Type No.	A	B	C	D	Available (Current rating: 7.5A max.)
 <p>EIAJ equivalent</p>	P4A	5.5	3.4	11.0	1.0	
	P4B	6.5	4.4	11.0	1.4	
	P4C	7.4	5.1	11.0	0.6	
Min. DIN 3 Pin with Lock (male)	Type No.	Pin Assignment		Available (Current rating: 7.5A max.)		
 <p>KYCON KPPX-3P equivalent</p>	R6B	PIN No.	Output			
		1	+Vo			
		2	-Vo			
	3	+Vo				
Min. DIN 4 Pin with Lock (male)	Type No.	Pin Assignment		Available (Current rating: 7.5A max.)		
 <p>KYCON KPPX-4P equivalent</p>	R7B	PIN No.	Output			
		1	+Vo			
		2	-Vo			
		3	-Vo			
	4	+Vo				
Stripped and tinned leads	Type No.	Pin Assignment		None		
 <p>Length of Land L1 by request (MW's standard length, L: <u>25</u> mm, L1: <u>10</u> mm)</p>	by customer	PIN No.	Output			
		1 (Ribbed)	+Vo			
	2 (Letter)	-Vo				

■ Installation Manual

Please refer to : <http://www.meanwell.com/manual.html>