



CFM500S SERIES 500 WATT AC-DC POWER SUPPLY WITH PFC

Features

- Universal Input Range 80~264V_{ac}
- High Efficiency up to 94.5%
- 3"x 5" Compact Size
- Class I
- No Load Power Consumption < 0.5W (NOTE 7)
- Peak Power Operation up to 600Watt for 5s
- Approval IEC/EN/UL 62368-1
- Approval EN 55032, 47 CFR FCC Part 15
- Active PFC Meets EN 61000-3-2
- Design Meets IEC/EN 60335-1
- Operating Altitude 5000m
- High Power Density up to 21.64W/Inch³
- 390W Natural, 470 ~ 500W Conduction Convection
- Over Temperature Protection
- PS On/Off Remote Control
- Power Good & Power Fail Signal
- +5V Stand-by, 12V Fan Output
- Low Inrush Current
- Parallel Operation Option (Active Current Sharing)
- PMBus Option



MODEL NUMBER	OUTPUT VOLTAGE	OUTPUT CURRENT			VOLTAGE ACCURACY NOTE2	RIPPLE & NOISE NOTE3	VOLTAGE ADJ. RANGE	LINE REGULATION NOTE4	LOAD REGULATION NOTE5	%EFF. (Typ.)
		NOTE1		COVER						
		With FAN	Without FAN							
CFM500S120	12 V	41.67A	27.5A	25A	±1%	120mV	11.4~12.6 V	±0.5%	±1%	92.5%
CFM500S180	18 V	27.78A	18.33A	16.67A	±1%	150mV	17.1~18.9 V	±0.5%	±1%	93.5%
CFM500S240	24 V	20.83A	17.08A	15.83A	±1%	150mV	22.8~25.2 V	±0.5%	±1%	94.5%
CFM500S280	28 V	17.86A	14.64A	13.57A	±1%	200mV	26.6~29.4 V	±0.5%	±1%	94.5%
CFM500S300	30 V	16.67A	13.66A	12.67A	±1%	200mV	28.5~31.5 V	±0.5%	±1%	94.5%
CFM500S360	36 V	13.89A	11.39A	10.56A	±1%	200mV	34.2~37.8 V	±0.5%	±1%	94.5%
CFM500S480	48 V	10.42A	8.54A	7.92A	±1%	250mV	45.6~50.4 V	±0.5%	±1%	94.5%
Stand-by Output Voltage										
All	+5V	1A			±3%	100mV	---	±1%	±5%	---
Fan Output Voltage										
All	+12V	0.5A (NOTE 6)			---	---	---	---	---	---

Note:

1. Forced air convection with 21CFM Fan.
2. Voltage accuracy is set at 100% full load and 25°C Ta.
3. Add a 0.1uF ceramic capacitor and a 10uF E.L. capacitor to output for ripple & noise measuring @20MHz BW.
4. Line regulation is measured from high line to low line with 100% full load.
5. Load regulation is measured from 10% to 100% full load.
6. Fan output can only operate normal when the stand-by output is above 0.5A.
7. CFM500SXXX-PM is not included; the no load power consumption of CFM500SXXX-PM is <1W.



CFM500S Series

PART NUMBER

Series	Number of Outputs	Nominal Output Voltage	Type	Function	Output Terminal
CFM500	X	XXX	X (Option)	-XX(Option)	-X(Option)
CFM500	S : Single	120 : 12V 180 : 18V 240 : 24V 280 : 28V 300 : 30V 360 : 36V 480 : 48V	None : With Baseplate C : With Cover	PC : Parallel Control PM : PMBus Protocol	None : Vertical R : Horizontal

Part Number Example:

CFM500S120: With Baseplate, 500W, 12Vdc Output, Vertical Type Terminal

CFM500S120C: With Cover, 500W, 12Vdc Output, Vertical Type Terminal

CFM500S120-R: With Baseplate, 500W, 12Vdc Output, Horizontal Type Terminal

CFM500S120C-R: With Cover, 500W, 12Vdc Output, Horizontal Type Terminal

CFM500S120-PC: With Baseplate, 500W, 12Vdc Output, Parallel Control, Vertical Type Terminal

CFM500S120-PM: With Baseplate, 500W, 12Vdc Output, PMBus Protocol, Vertical Type Terminal



CFM500S Series

TECHNICAL SPECIFICATIONS

(All specifications are typical at nominal input, full load at 25°C unless otherwise noted.)

ABSOLUTE MAXIMUM RATINGS

PARAMETER	NOTES and CONDITIONS	Device	Min.	Typ.	Max.	Units
Input Voltage	Safety approvals only to the AC input	All	80		264	V _{ac}
Operating Temperature	See Derating Curve	All	-40		85	°C
Maximum Case Temperature	At the center of base plate (T _c = Case temperature)	All	-40		85	°C
Storage Temperature		All	-40		85	°C
Operating Altitude		All			5000	m

INPUT CHARACTERISTICS

PARAMETER	NOTES and CONDITIONS	Device	Min.	Typ.	Max.	Units
Operating Voltage Range		All	100		240	V _{ac}
Input Frequency Range		All	47		63	Hz
Maximum Input Current	100% Full Load, V _{in} =100V _{ac}	All			6	A
Power Factor	V _{in} =230V _{ac}	All		0.97		
Leakage Current (Earth)		All			300	uA
Leakage Current (Touch)		All			100	uA
Inrush Current	V _{in} =240V _{ac} , Cold start at 25°C	All		8.5		A

OUTPUT CHARACTERISTICS

PARAMETER	NOTES and CONDITIONS	Device	Min.	Typ.	Max.	Units
Output Voltage Set Point	V _{in} =Nominal V _{in} , I _o =I _o max., T _c =25°C	CFM500S120	11.88	12	12.12	V _{dc}
		CFM500S180	17.82	18	18.18	
		CFM500S240	23.76	24	24.24	
		CFM500S280	26.6	28	29.4	
		CFM500S300	28.5	30	31.5	
		CFM500S360	35.64	36	36.36	
		CFM500S480	47.52	48	48.48	
Operating Output Current Range	V _{in} =80V _{ac} ~264V _{ac} , See Derating Curve	CFM500S120			41.67	A
		CFM500S180			27.78	
		CFM500S240			20.83	
		CFM500S280			17.86	
		CFM500S300			16.67	
		CFM500S360			13.89	
		CFM500S480			10.42	
Holdup Time	V _{in} =115V _{ac}	All		16		ms
Output Voltage Regulation						
Load Regulation	10% to 100% full load	All			±1.0	%
Line Regulation	V _{in} =High line to low line	All			±0.5	%
Over Voltage Protection	Latch off (AC recycle to reset)	CFM500S120			16	V _{dc}
		CFM500S180			30	
		CFM500S240			35	
		CFM500S280			35	
		CFM500S300			35	
		CFM500S360			50	
		CFM500S480			63	
Over Current Protection	Auto recovery	All	120		190	%



CFM500S Series

PARAMETER	NOTES and CONDITIONS	Device	Min.	Typ.	Max.	Units
Peak Power	1. $V_{in}=115V_{ac}$ and $230V_{ac}$ 2. Ambient temperature= $25^{\circ}C$ 3. Peak power should be less than 5seconds, with a maximum 10% duty cycle, peak power function by 120% load 5S and 75% load 45S	All		120		%
Short Circuit Protection	Auto recovery	All				
Over Temperature Protection	Auto recovery	All				
Current Sharing Accuracy	50% to 100% full load	Option	-5		+5	%
Output Ripple and Noise	1. Add a 0.1uF ceramic capacitor and a 10uF aluminum electrolytic capacitor to output 2. Oscilloscope is 20MHz bandwidth 3. Ambient temperature= $25^{\circ}C$	CFM500S120 CFM500S180 CFM500S240 CFM500S280 CFM500S300 CFM500S360 CFM500S480			120 150 150 200 200 200 250	mV
Load Capacitance	1. $V_{in}=115V_{ac}$ and $230V_{ac}$ 2. Output is 100% full load 3. Ambient temperature= $25^{\circ}C$	CFM500S120 CFM500S180 CFM500S240 CFM500S280 CFM500S300 CFM500S360 CFM500S480			42900 28600 20800 18000 16600 14000 10800	μF
Efficiency	1. $V_{in}=230V_{ac}$ 2. Output is 100% full load 3. Ambient temperature= $25^{\circ}C$	CFM500S120 CFM500S180 CFM500S240 CFM500S280 CFM500S300 CFM500S360 CFM500S480		92.5 93.5 94.5 94.5 94.5 94.5 94.5		%
PS-On Signal (Absolute Maximum Rating:60V)	Power on	All	0		2	V_{dc}
	Power off (PS-ON and GND open)			4		
	Power on (PS-ON and GND short)			10		mA
	Power-off (PS-ON and GND open)			0		
Power Good (PG)	1. $V_{in}=80V_{ac}\sim 264V_{ac}$ 2. Output is 100% full load 3. The TTL goes high after power set up	All	100		500	ms
Power Fail (PF)	1. $V_{in}=80V_{ac}\sim 264V_{ac}$ 2. Output is 100% full load 3. The TTL goes low before V_o below 90% rated value	All	1	10		ms

ISOLATION CHARACTERISTICS

PARAMETER	NOTES and CONDITIONS	Device	Min.	Typ.	Max.	Units
Input to Output	1 Minute	All			4000	V_{ac}
Input to Earth (Ground)	1 Minute (without dielectric breakdown)	All			1800	V_{ac}
Output to Earth (Ground)	1 Minute (without dielectric breakdown)	All			1800	V_{ac}
Isolation Resistance	Input to output	All	100			$M\Omega$

FEATURE CHARACTERISTICS

PARAMETER	NOTES and CONDITIONS	Device	Min.	Typ.	Max.	Units
Switching Frequency	$P_{out}=\max.$ rated power	All		65		kHz
Output Voltage adjustment		All	-5		+5	%



CFM500S Series

GENERAL SPECIFICATIONS

PARAMETER	NOTES and CONDITIONS	Device	Min.	Typ.	Max.	Units
MTBF	$I_o=100\%$; $T_a=25^\circ\text{C}$ per MIL-HDBK-217F	All		200		k hours
Humidity	Non-condensing	All			93	% RH
Shock	Meet MIL-STD-810F Table 516.5, Table 516.5-I 10ms, each axis 3 times($\pm X$ 、 $\pm Y$ 、 $\pm Z$ axis)	All		75		g
Vibration	Meet MIL-STD-810F Table 514.5C-VIII, 15~2000Hz, X、Y、Z axis, 1 hour (each axis),. Total 3 hrs.	All		4		g
Weight	Baseplate versions Covered versions	All		515 635		g
Dimensions	With baseplate C (with cover)	All	5.000x3.000x1.540 Inches (127.00x76.20x39.10 mm) 5.354x3.425x1.673 Inches (136.00x87.00x42.50 mm)			
Safety	Class I, IEC 62368-1:2014, EN 62368-1:2014/A11:2017, UL 62368-1					Ed 3.0
EMC Emission	EN 55032:2015+AC:2016, EN 61000-6-3 2007+A1: 2011+AC: 2012, Class B EN 61000-6-4:2007+A1:2011, 47 CFR FCC Part 15 Subpart B (Class B) EN 61204-3:2000, EN 61000-3-2:2014, EN 61000-3-3:2013					
Conducted Disturbance	EN 55032:2015+AC:2016, EN 61000-6-3 2007+A1: 2011+AC: 2012, Class B EN 61000-6-4:2007+A1:2011, 47 CFR FCC Part 15 Subpart B (Class B)					Class B
Radiated Disturbance	EN 55032:2015+AC:2016, EN 61000-6-3 2007+A1: 2011+AC: 2012, Class B EN 61000-6-4:2007+A1:2011, 47 CFR FCC Part 15 Subpart B (Class B)					Class B
Harmonic Current Emissions	IEC 61000-3-2:2014					Class A, C, D
Voltage Fluctuations & Flicker	IEC 61000-3-3:2013					
EMC Immunity	EN 55035:2017, EN61000-6-1:2019+CRGD:2018, EN 61000-6-2:2019 EN 61204-3:2000, IEC 61000-4-2, 3, 4, 5, 6, 8, 11					
Electrostatic Discharge (ESD)	IEC 61000-4-2:2008, Air Discharge: $\pm 8\text{kV}$, Contact Discharge: $\pm 4\text{kV}$					Criterion A
Radio-Frequency, Continuous Radiated Disturbance	IEC 61000-4-3:2006+A1:2007+A2:2010					Criterion A
Electrical Fast Transient (EFT)	IEC 61000-4-4:2012, $\pm 1\text{kV}$, $\pm 2\text{kV}$					Criterion A
Surge	IEC 61000-4-5:2014+A1:2017, L-N: $\pm 0.5\text{kV}$, $\pm 1\text{kV}$, L-E(Ground): $\pm 0.5\text{kV}$, $\pm 1\text{kV}$, $\pm 2\text{kV}$					Criterion A
Conducted Disturbances, Induced by RF Fields	IEC 61000-4-6:2013+COR1:2015					Criterion A
Power Frequency Magnetic Field	IEC 61000-4-8:2009					Criterion A
Voltage Dips	IEC 61000-4-11:2004+A1:2017, Dip: 30% Reduction, Dip >95% Reduction					Criterion A
Voltage Interruptions	IEC 61000-4-11:2004+A1:2017, >95% Reduction					Criterion B
Application Note Link	CFM500S Series App Notes					

PMBus Monitoring and Programming Functions

Function	PMBus Commands
Output Voltage Data Format	Read only
Output Voltage Monitor	Read only
Output Power Monitor	Read only
Output Current Monitor	Read only
Input Voltage Monitor	Read only
Internal Temperature Monitor	Read only
Remote On/Off	Write/Read
Manufacturing Information	Read only



CFM500S Series

CHARACTERISTIC CURVE

Power Derating Curve

Forced Air Flow

Output power & Input voltage

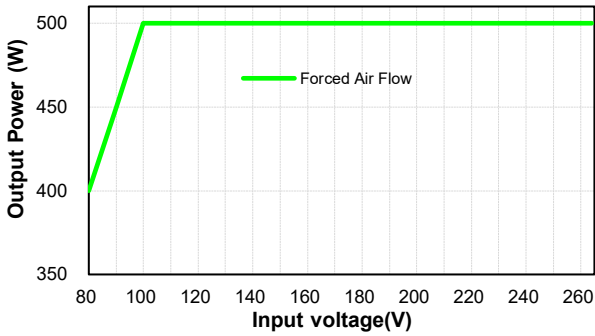

Forced Air Flow

Output power vs Ambient Temperature

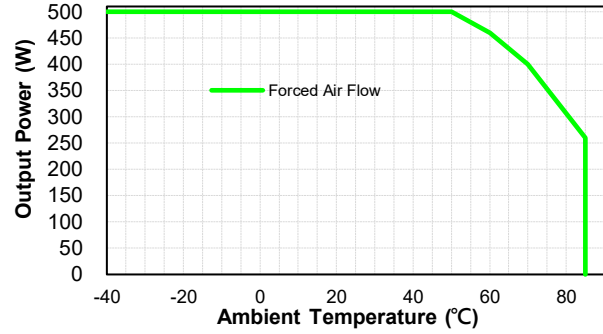

Natural Convection

Output power & Input Voltage

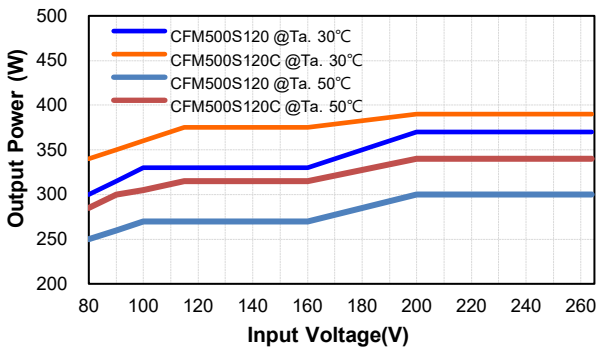

Natural Convection

Output power vs Ambient Temperature

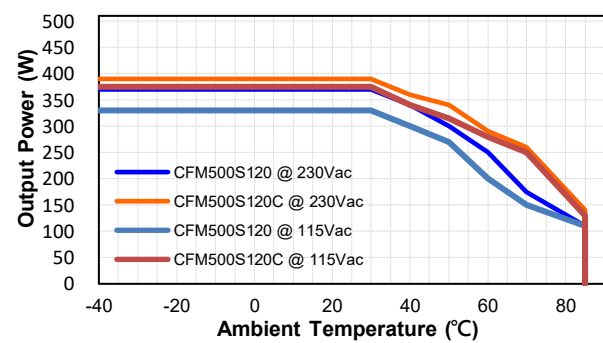

Output power & Input Voltage

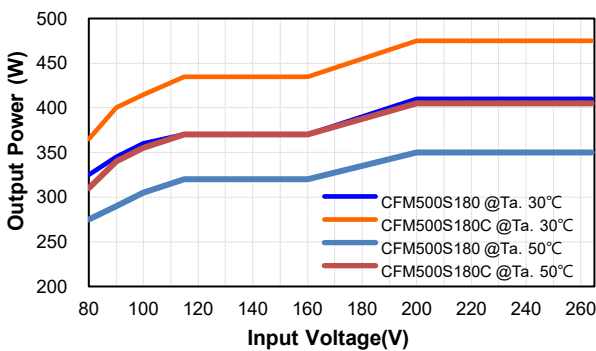

Output power vs Ambient Temperature

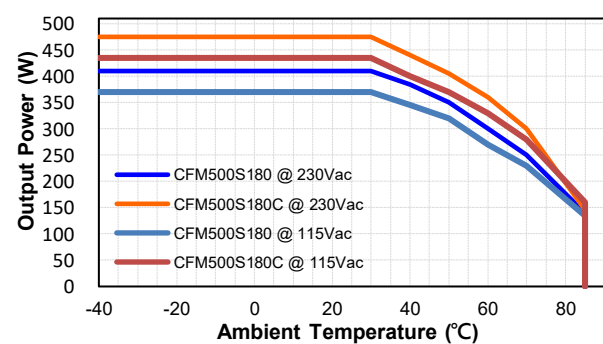



CFM500S Series

Output power & Input Voltage

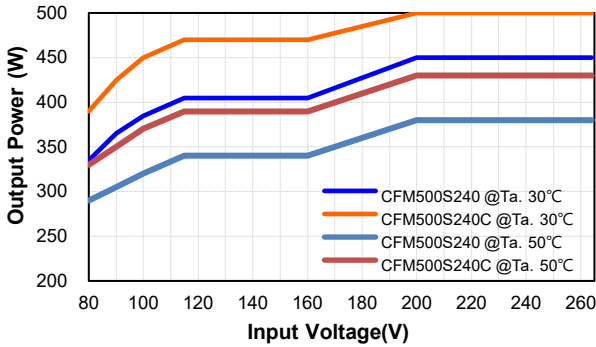

Output power vs Ambient Temperature

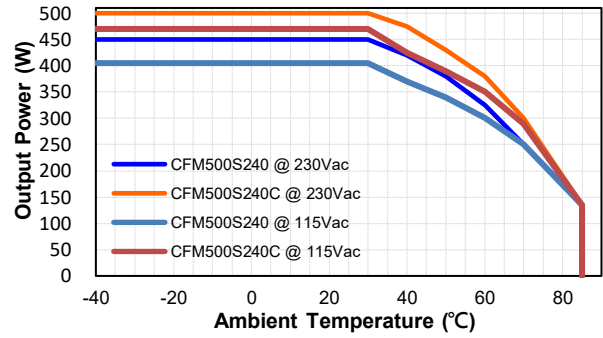

Output power & Input Voltage

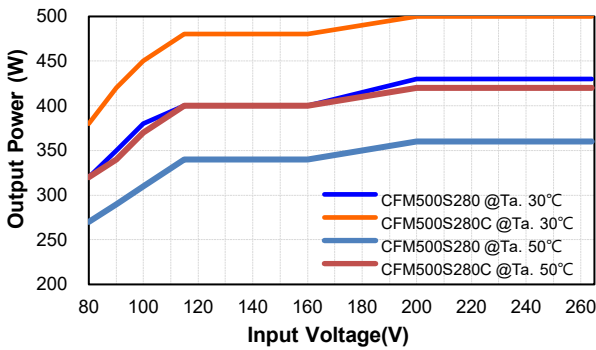

Output power vs Ambient Temperature

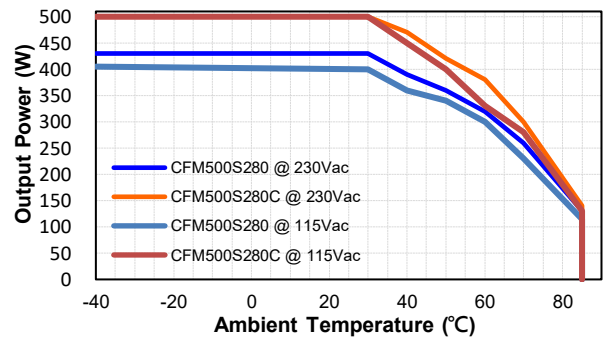

Output power & Input Voltage

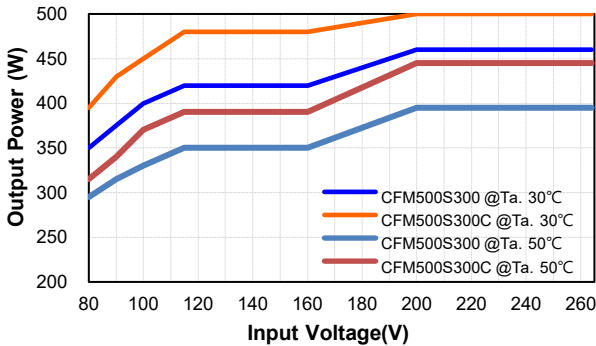

Output power vs Ambient Temperature

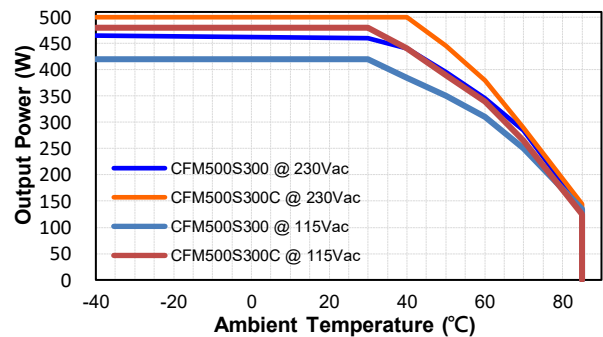

Output power & Input Voltage

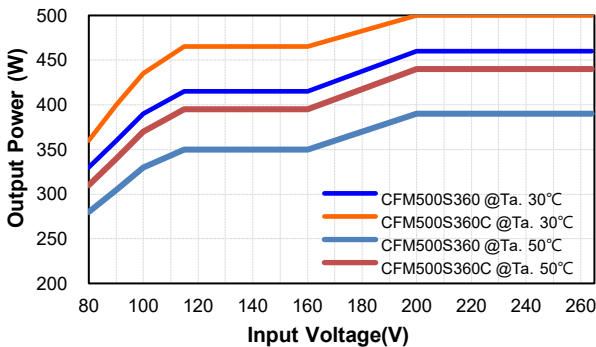

Output power vs Ambient Temperature

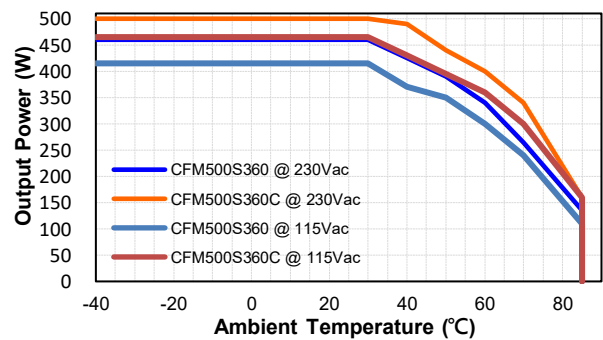



CFM500S Series

Output power & Input Voltage

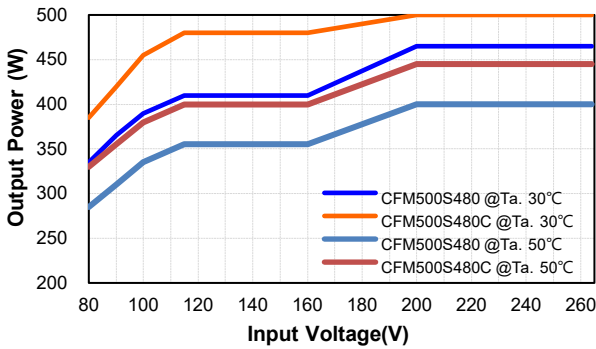

Output power vs Ambient Temperature

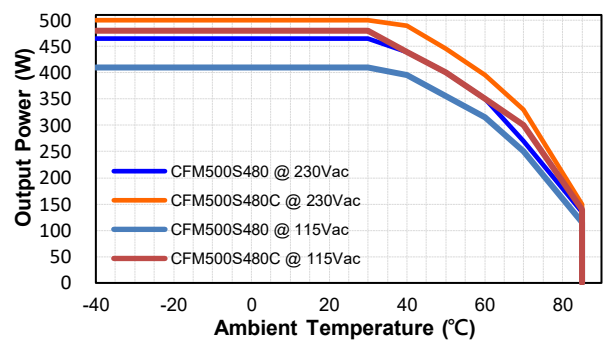

Conduction Convection with External Baseplate (48x24.8x0.12cm)

Output power & Input Voltage

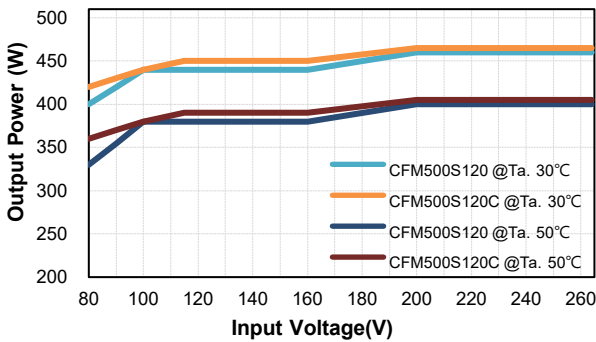

Output power vs Ambient Temperature

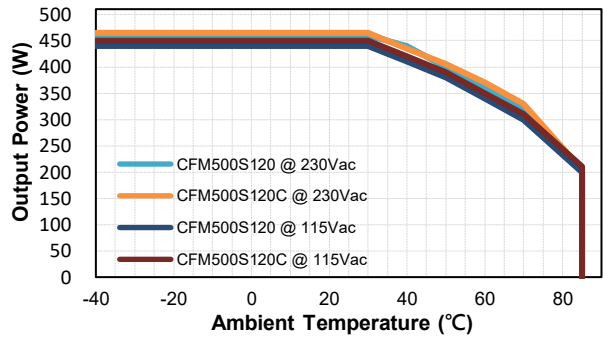

Output power & Input Voltage

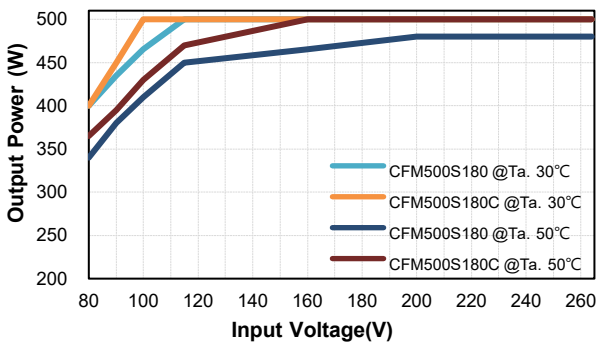

Output power vs Ambient Temperature

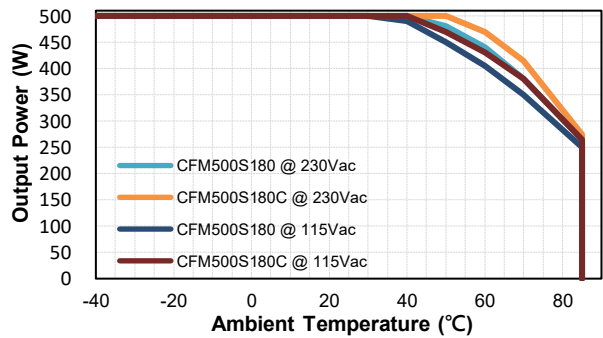

Output power & Input Voltage

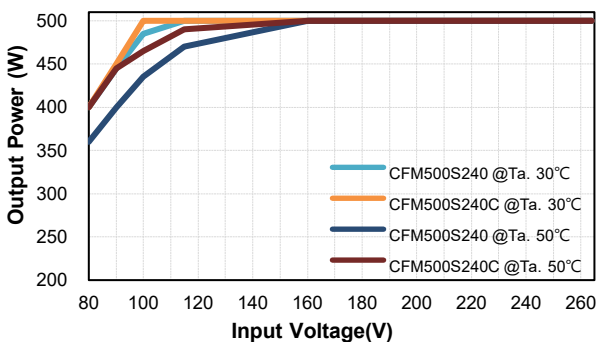

Output power vs Ambient Temperature

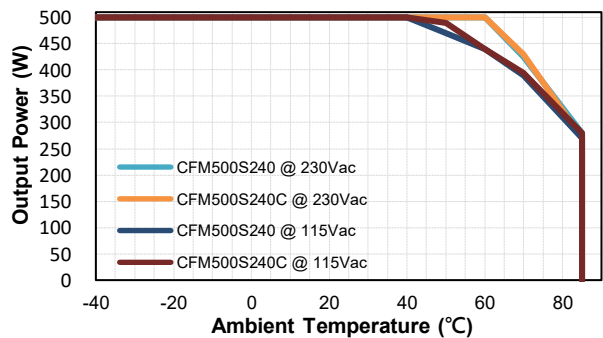



CFM500S Series

Output power & Input Voltage

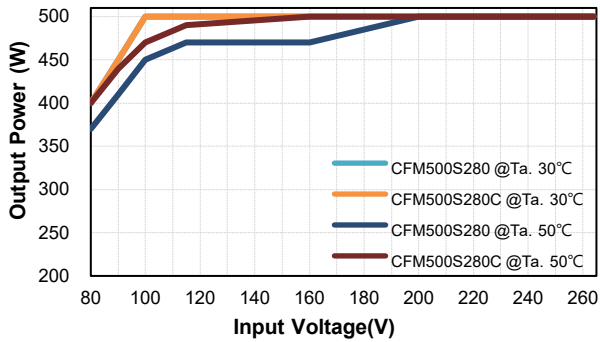

Output power vs Ambient Temperature

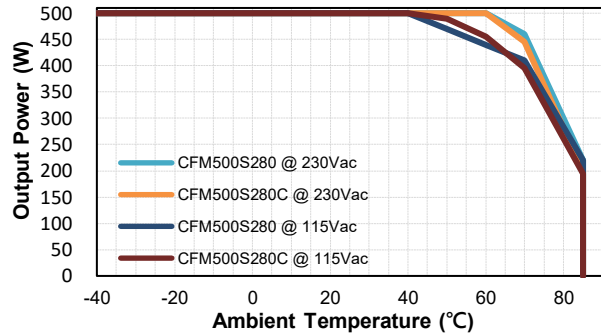

Output power & Input Voltage

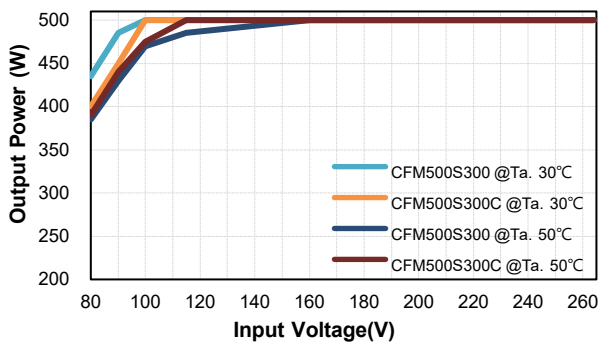

Output power vs Ambient Temperature

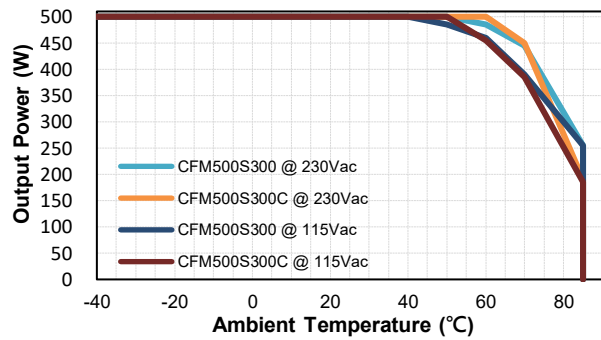

Output power & Input Voltage

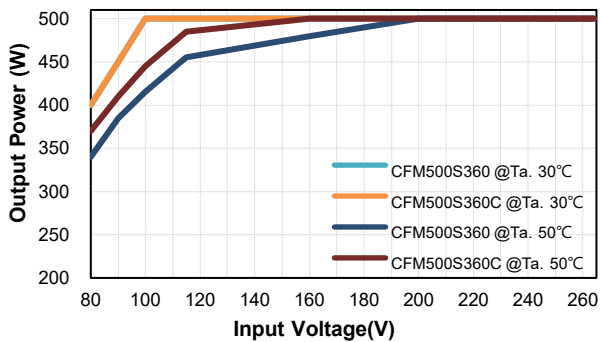

Output power vs Ambient Temperature

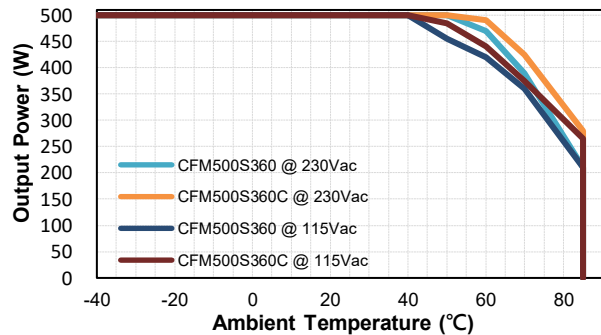

Output power & Input Voltage

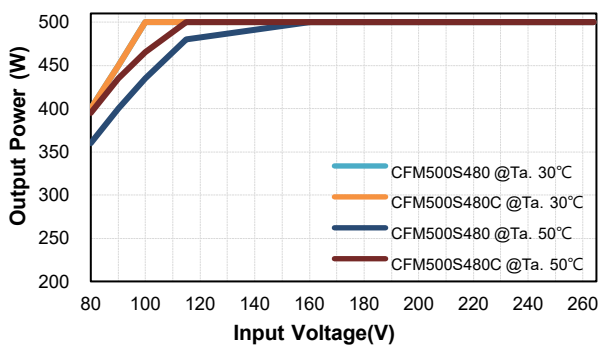

Output power vs Ambient Temperature

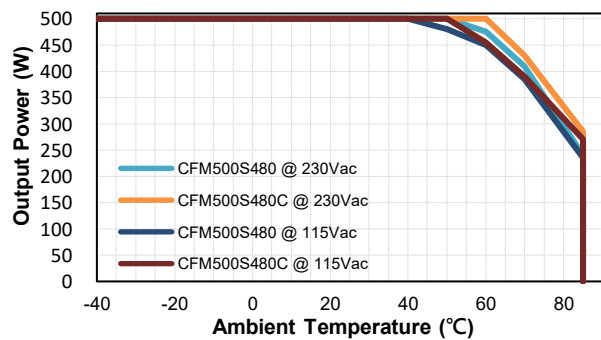



CFM500S Series

Output Power vs Case Temperature (Tc)

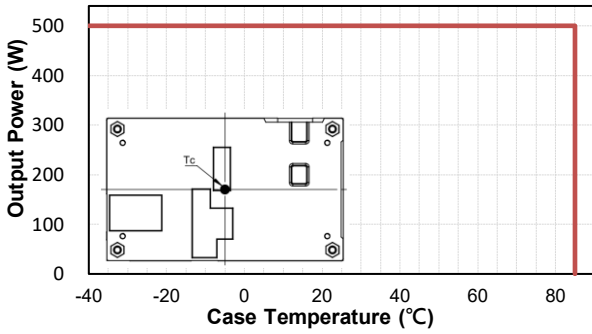

Performance Data

CFM500S120 (Eff Vs Io)

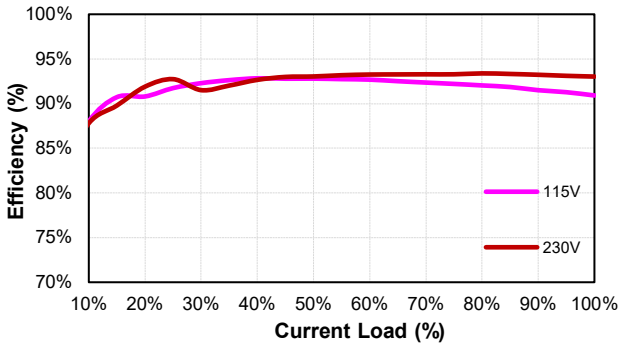

CFM500S180 (Eff Vs Io)

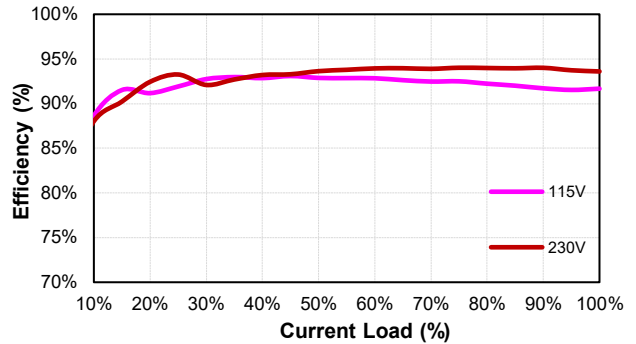

CFM500S240 (Eff Vs Io)

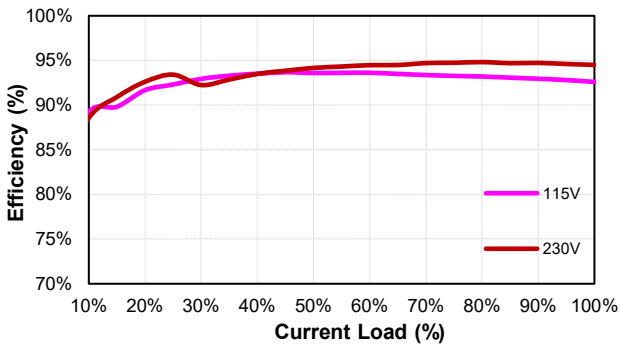

CFM500S280 (Eff Vs Io)

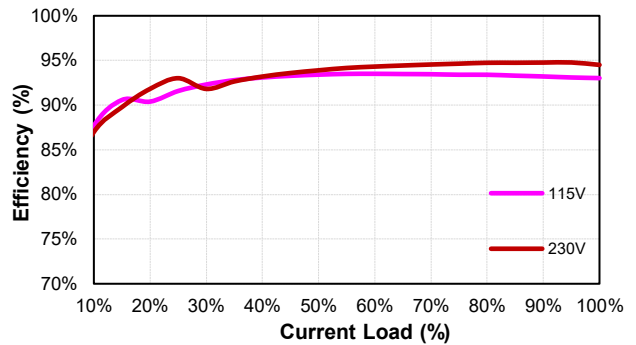

CFM500S300 (Eff Vs Io)

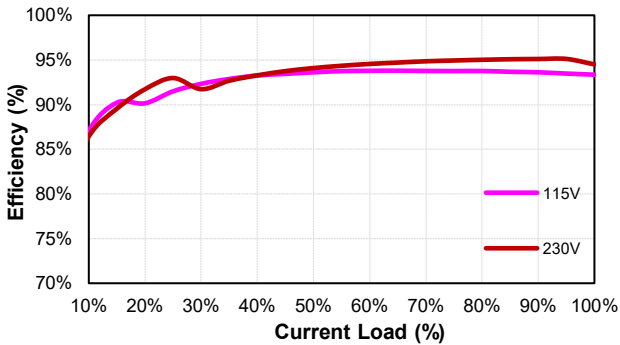

CFM500S360 (Eff Vs Io)

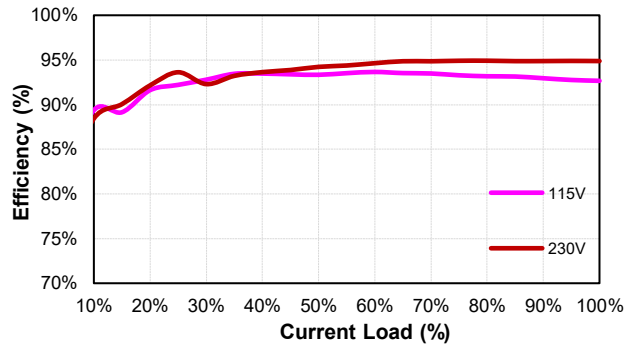



CFM500S Series

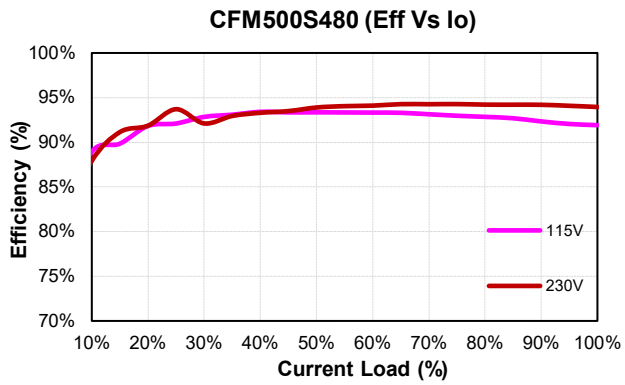



CFM500S Series

MECHANICAL SPECIFICATION

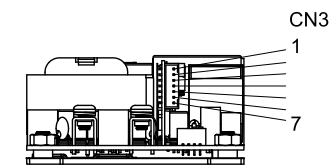
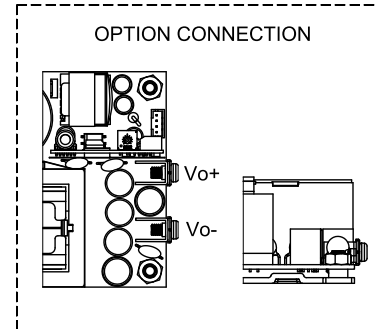
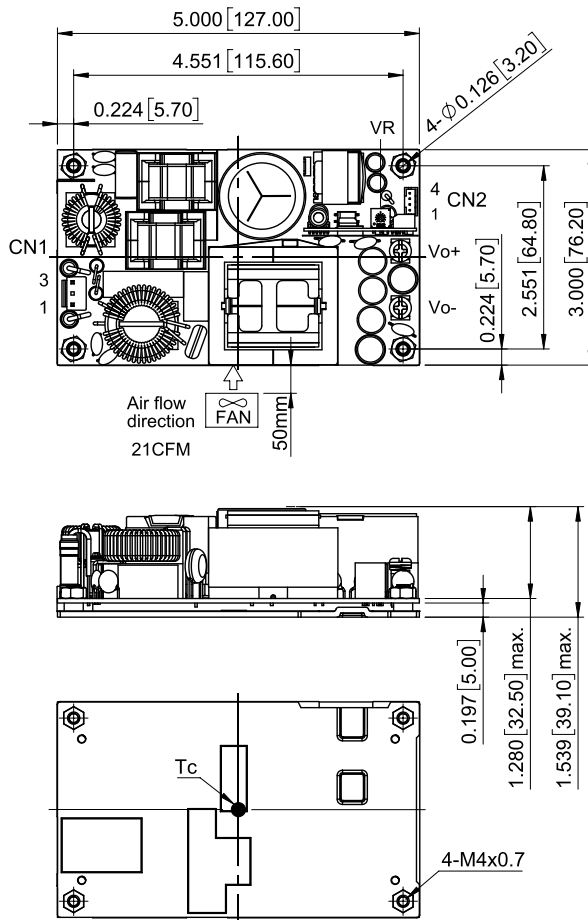

CFM500SXXX

All Dimensions in Inches[mm]

Tolerance Inches: x.xxx \pm 0.020

Millimeters: x.xx \pm 0.50

AC Input Connector(CN1):JST B2P3-VH or equivalent

Pin	Function	Mating Housing	Terminal
1	ACL	JST VHR-3N or equivalent	JST SVH-41T-P1.1 or equivalent
2	-		
3	ACN		

DC Output Connector(CN2):TKP P110I-04 or equivalent

Pin	Function	Mating Housing	Terminal
1	GND	JST PHR-4 or equivalent	JST SPH-002T-P0.5L or equivalent
2	+5VSB		
3	GND		
4	+12V-FAN		

DC Output Connector(CN3):TKP P110L-07 or equivalent

Pin	Function	Mating Housing	Terminal
1	GND	JST PHR-7 or equivalent	JST SPH-002T-P0.5L or equivalent
2	PG/PF		
3	FAN-EN		
4	PS-ON		
5	-Sense		
6	+Sense		
7	PC(Optional)		

DC Output Connector:KANG YANG PCB-58M4 or equivalent

Function	The screw locked torque
Vo-	M4 7kgf-cm
Vo+	



CFM500S Series

MECHANICAL SPECIFICATION

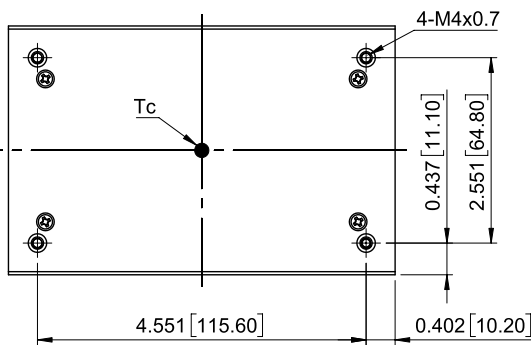
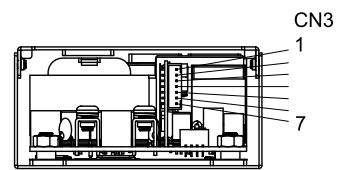
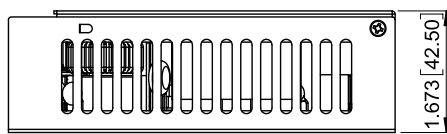
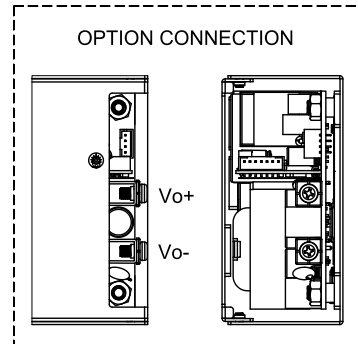
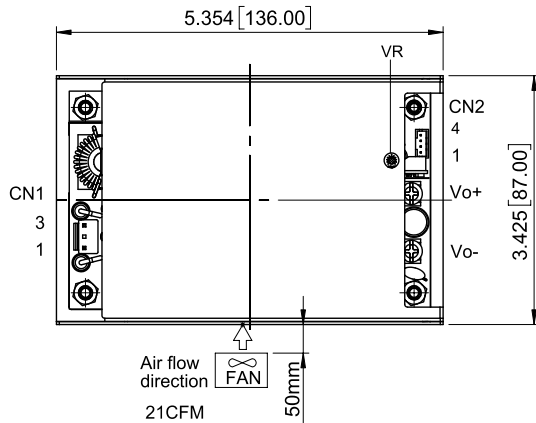

All Dimensions in Inches[mm]
Tolerance Inches: x.xxx \pm 0.020
Millimeters: x.xx \pm 0.50

AC Input Connector(CN1):JST B2P3-VH or equivalent

Pin	Function	Mating Housing	Terminal
1	ACL	JST VHR-3N or equivalent	JST SVH-41T-P1.1 or equivalent
2	-		
3	ACN		

DC Output Connector(CN2):TKP P110I-04 or equivalent

Pin	Function	Mating Housing	Terminal
1	GND	JST PHR-4 or equivalent	JST SPH-002T-P0.5L or equivalent
2	+5VSB		
3	GND		
4	+12V-FAN		

DC Output Connector(CN3):TKP P110L-07 or equivalent

Pin	Function	Mating Housing	Terminal
1	GND	JST PHR-7 or equivalent	JST SPH-002T-P0.5L or equivalent
2	PG/PF		
3	FAN-EN		
4	PS-ON		
5	-Sense		
6	+Sense		
7	PC(Optional)		

DC Output Connector:KANG YANG PCB-58M4 or equivalent

Function	The screw locked torque
Vo-	M4 7kgf-cm
Vo+	



CFM500S Series

MECHANICAL SPECIFICATION

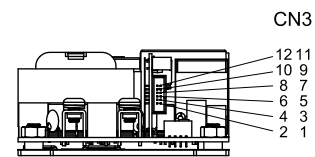
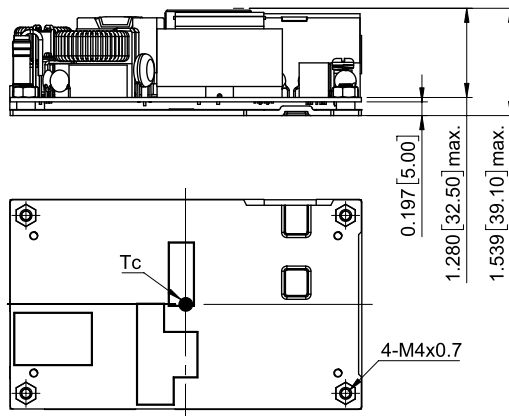
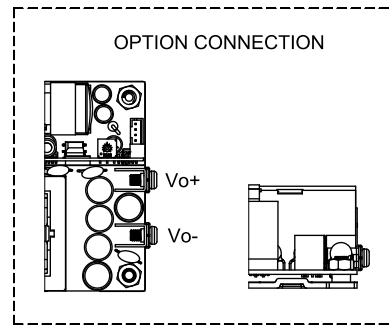
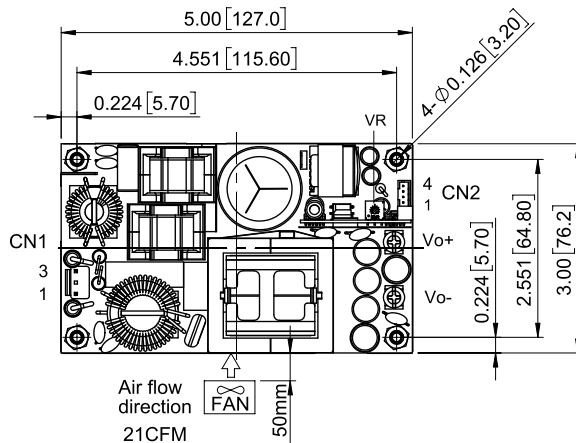

CFM500SXXX-PM

All Dimensions in Inches[mm]
 Tolerance Inches: x.xx=±0.03, x.xxx=±0.020
 Millimeters: x.x=±0.7, x.xx=±0.50

AC Input Connector(CN1):JST B2P3-VH or equivalent

Pin	Function	Mating Housing	Terminal
1	ACL	JST VHR-3N or equivalent	JST SVH-41T-P1.1 or equivalent
2	-		
3	ACN		

DC Output Connector(CN2):TKP P110I-04 or equivalent

Pin	Function	Mating Housing	Terminal
1	GND	JST PHR-4 or equivalent	JST SPH-002T-P0.5L or equivalent
2	+5VSB		
3	GND		
4	+12V-FAN		

DC Output Connector(CN3):Townes B304F-12RGF-104-LH or equivalent

Pin	Function	Mating Housing
1	SGND	Samtec FFSD-06-01-N or equivalent
2	PMBus Clock	
3	PMBus Data	
4	PMBus Alert	
5	PMBus Addr2	
6	PMBus Addr1	
7	PS ON/OFF	
8	GND	
9	PG/PF	
10	NA	
11	Vsns-	
12	Vsns+	

DC Output Connector:KANG YANG PCB-58M4 or equivalent

Function	The screw locked torque
Vo-	M4 7kgf-cm
Vo+	



CFM500S Series

MECHANICAL SPECIFICATION

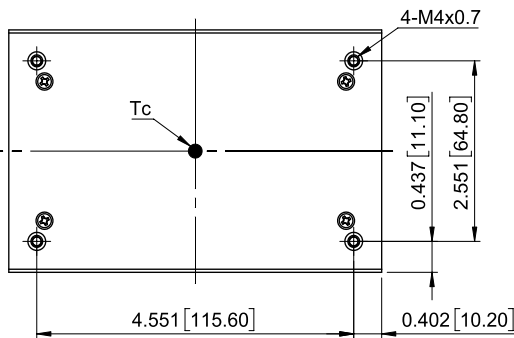
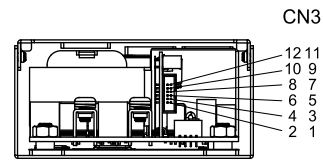
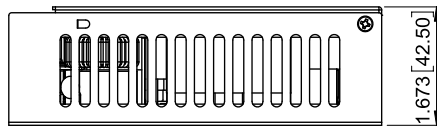
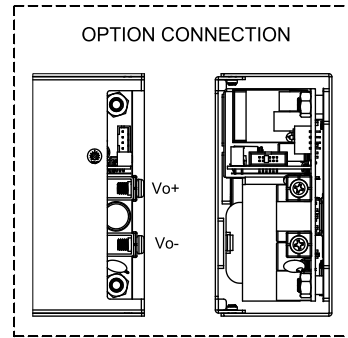
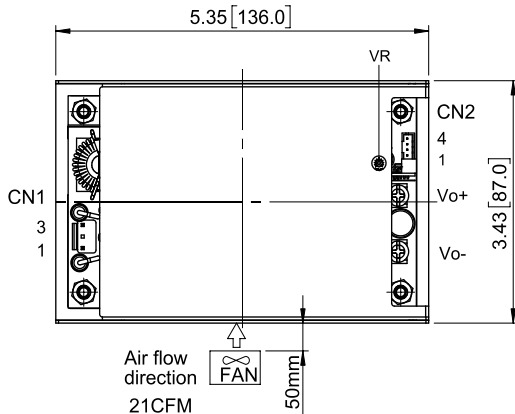

CFM500SXXXC-PM

All Dimensions in Inches[mm]
Tolerance Inches: x.xx=±0.03, x.xxx=±0.020
Millimeters: x.x=±0.7, x.xx=±0.50

AC Input Connector(CN1):JST B2P3-VH or equivalent

Pin	Function	Mating Housing	Terminal
1	ACL	JST VHR-3N or equivalent	JST SVH-41T-P1.1 or equivalent
2	-		
3	ACN		

DC Output Connector(CN2):TKP P110I-04 or equivalent

Pin	Function	Mating Housing	Terminal
1	GND	JST PHR-4 or equivalent	JST SPH-002T-P0.5L or equivalent
2	+5VSB		
3	GND		
4	+12V-FAN		

DC Output Connector(CN3):Townes B304F-12RGF-104-LH or equivalent

Pin	Function	Mating Housing
1	SGND	Samtec FFSD-06-01-N or equivalent
2	PMBus Clock	
3	PMBus Data	
4	PMBus Alert	
5	PMBus Addr2	
6	PMBus Addr1	
7	PS ON/OFF	
8	GND	
9	PG/PF	
10	NA	
11	Vsns-	
12	Vsns+	

DC Output Connector:KANG YANG PCB-58M4 or equivalent

Function	The screw locked torque
Vo-	M4 7kgf-cm
Vo+	

CINCON Electronics Co. Ltd.
Add: 14F, No. 306, Sec.4, Hsin Yi Rd., Taipei, Taiwan
Tel: 886-2-27086210
Fax: 886-2-27029852
E-mail: sales@cincon.com
Web: www.cincon.com